

DATE	ray 8.10.04		FRAMES	
JOB #	<h1>THARP CABINET ORDER</h1>			
Sheet 1 of 5				
Description Knutson new home		Address 8137 Admiral Drive, Loveland		
Name Shane Knutson		WOOD Alder	SOFFIT	
Phone 303-917-7503		STAIN Golden Pecan	DOOR upper: Patriot base: Revere	
Contact Shane		EDGE none	DRAWER Standard	
UPPERS 42"	TOPS granite	FINGERPULLS yes		
INSTALL self	DELIVER yes	FLOORS	HINGE 1 1/4 custom	

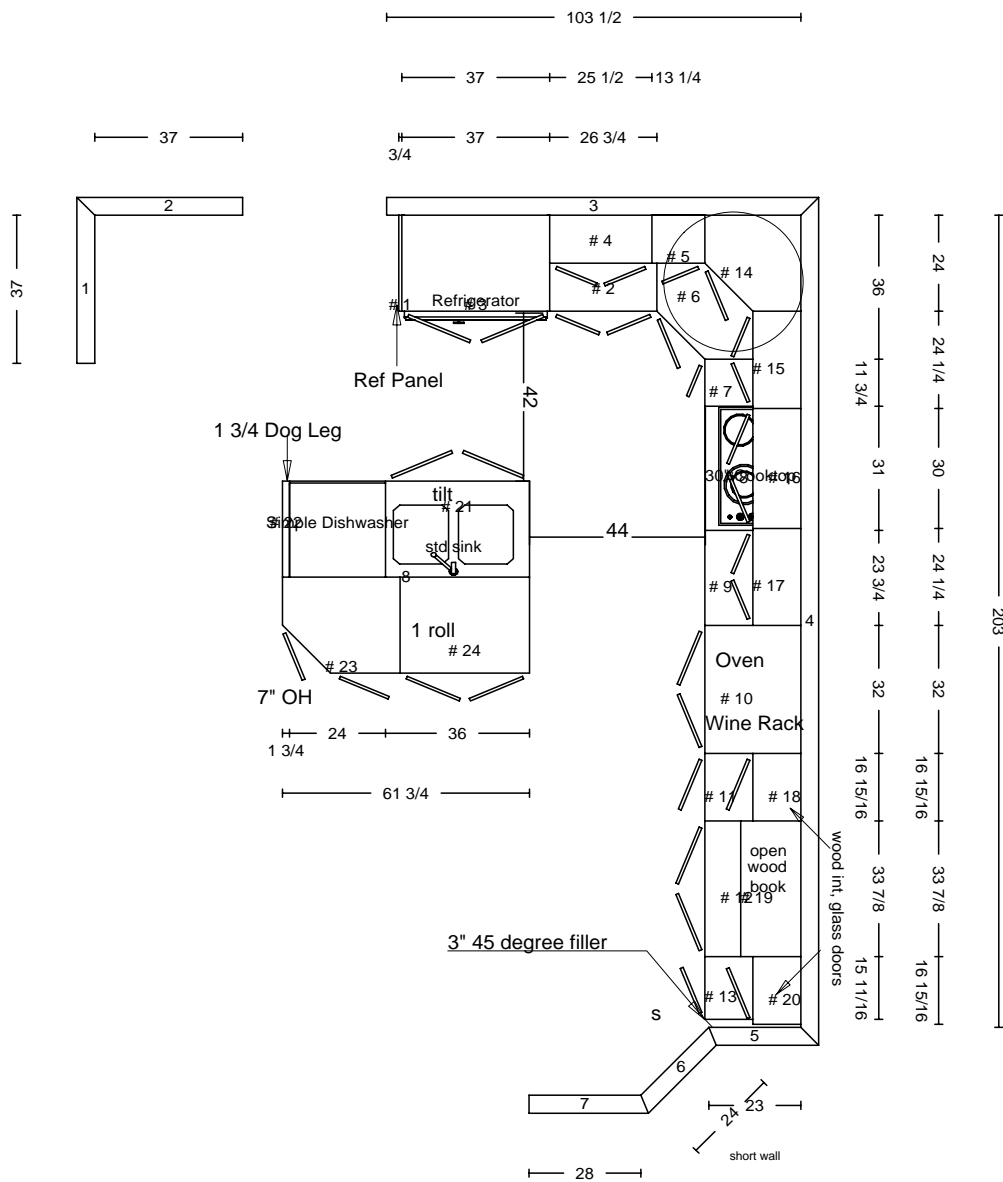

DATE	<h1>THARP CABINET ORDER</h1>			FRAMES	
JOB #					
Sheet 2 of 5					
Description Knutson new home		Address 8137 Admiral Drive, Loveland			
Name Shane Knutson		WOOD		SOFFIT	
Phone 303-917-7503		STAIN		DOOR	
Contact Shane		EDGE		DRAWER	
UPPERS		TOPS		FINGERPULLS	
INSTALL	DELIVER		FLOORS		HINGE

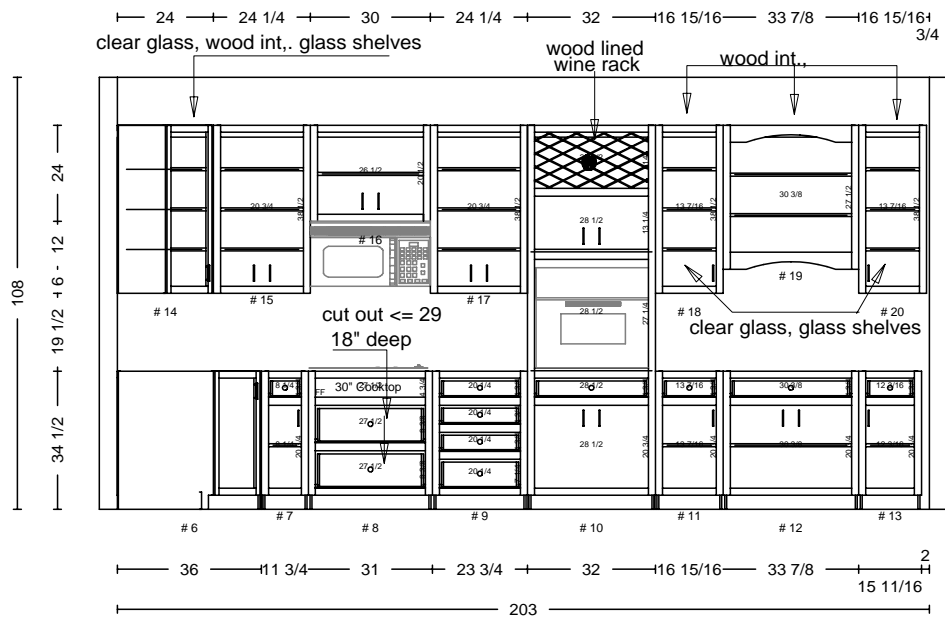
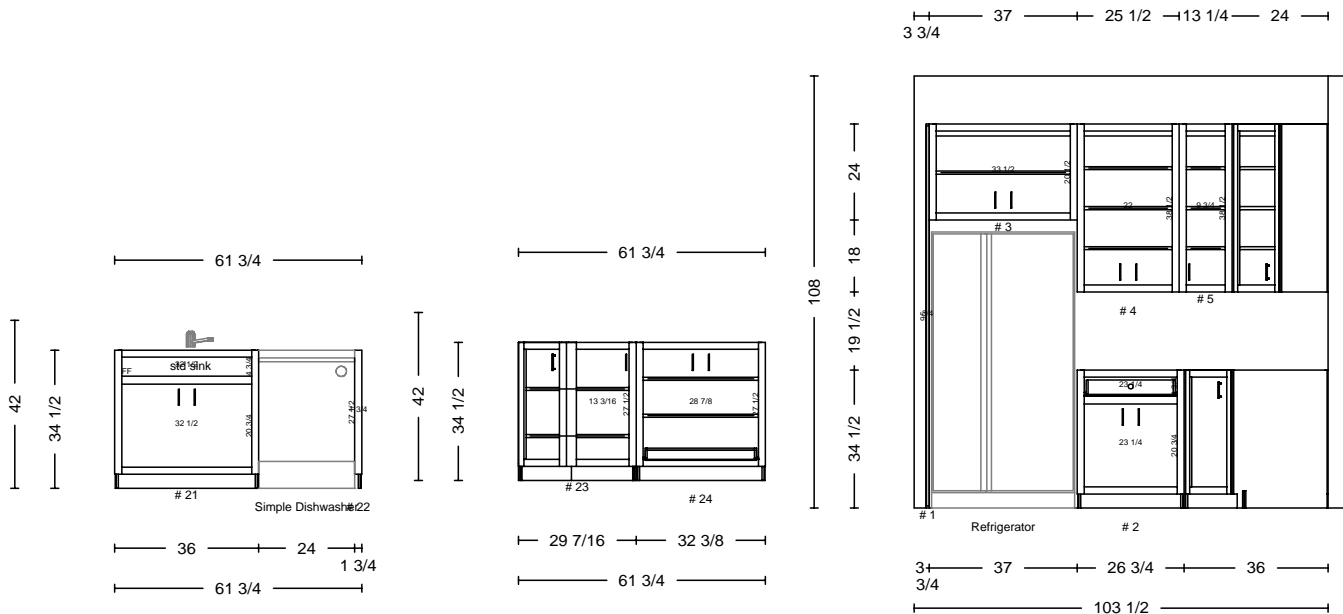

DATE	<h1>THARP CABINET ORDER</h1>			FRAMES	
JOB #					
Sheet 3 of 5					
Description Knutson new home		Address 8137 Admiral Drive, Loveland			
Name Shane Knutson		WOOD	SOFFIT		
Phone 303-917-7503		STAIN	DOOR		
Contact Shane		EDGE	DRAWER		
UPPERS		TOPS		FINGERPULLS	
INSTALL	DELIVER		FLOORS		HINGE

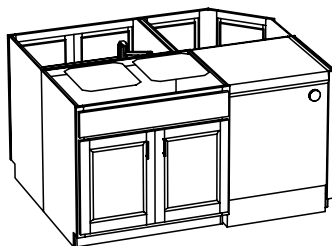
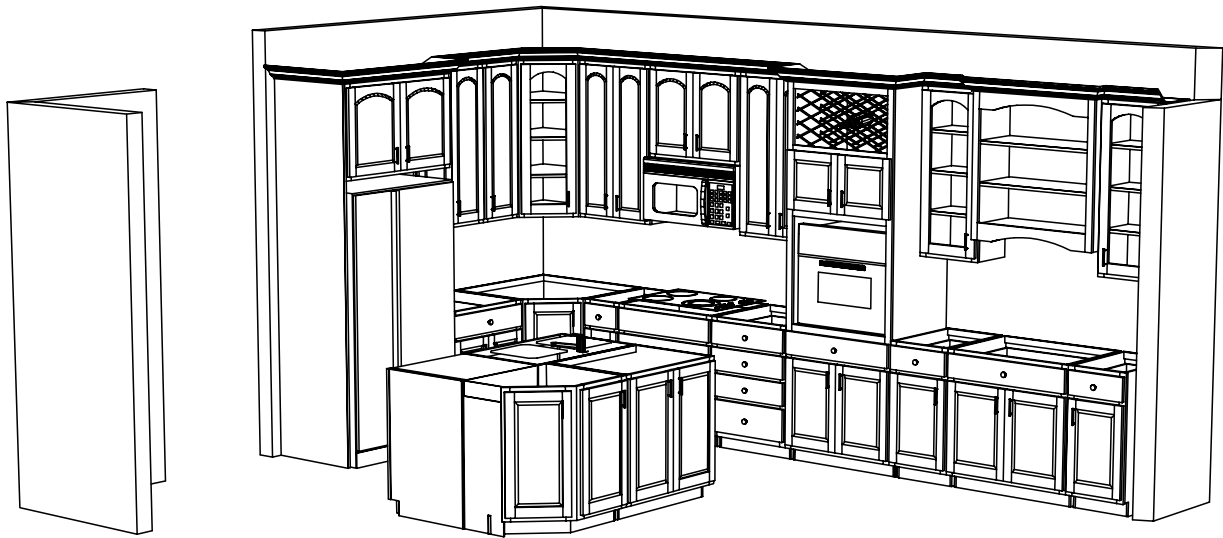

DATE	<h1>THARP CABINET ORDER</h1>		FRAMES	
JOB #				
Sheet 4 of 5				
Description Knutson new home		Address 8137 Admiral Drive, Loveland		
Name Shane Knutson		WOOD	SOFFIT	
Phone 303-917-7503		STAIN	DOOR	
Contact Shane		EDGE	DRAWER	
UPPERS		TOPS	FINGERPULLS	
INSTALL	DELIVER	FLOORS	HINGE	

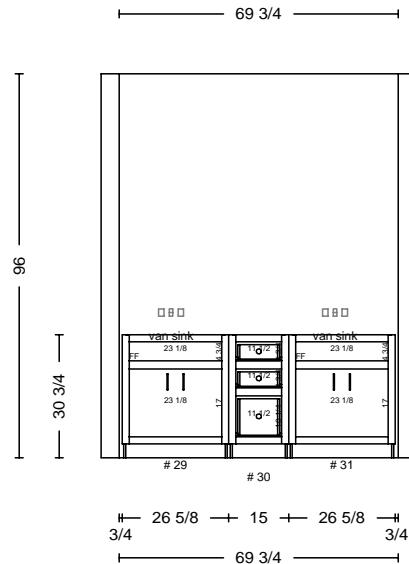
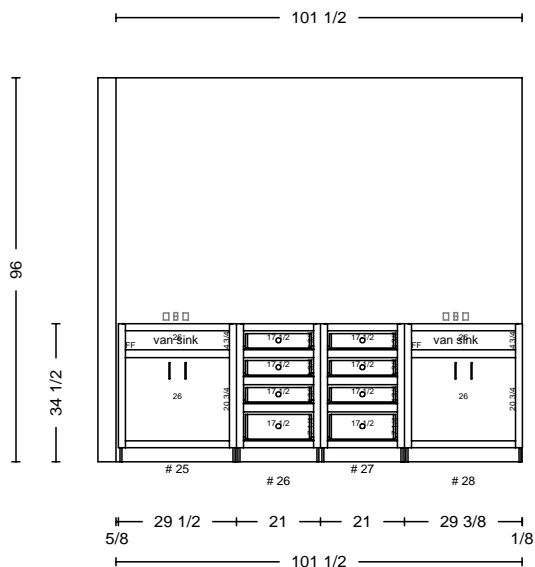
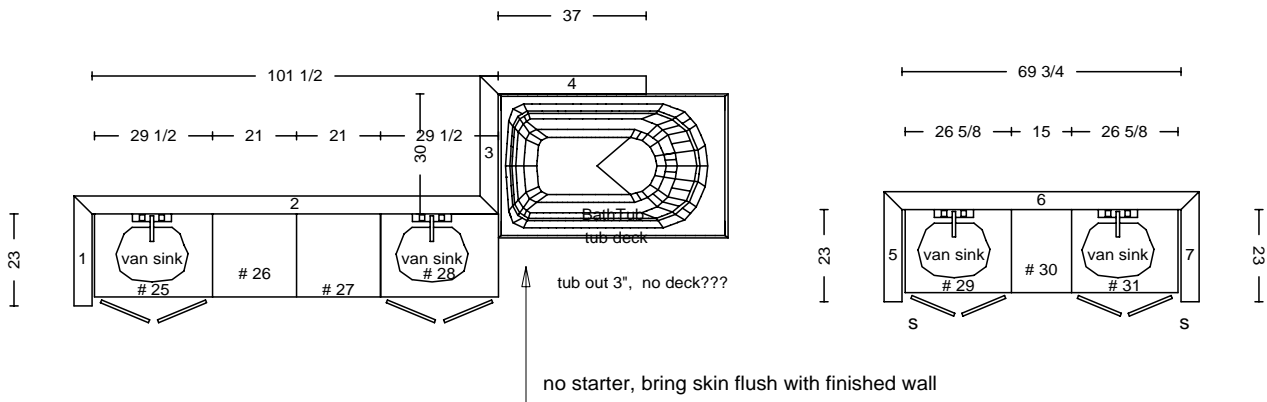

DATE	<h1>THARP CABINET ORDER</h1>			FRAMES	
JOB #					
Sheet 5 of 5					
Description Knutson new home		Address 8137 Admiral Drive, Loveland			
Name Shane Knutson		WOOD	SOFFIT		
Phone 303-917-7503		STAIN	DOOR		
Contact Shane		EDGE	DRAWER		
UPPERS		TOPS		FINGERPULLS	
INSTALL	DELIVER		FLOORS		HINGE

