

DATE	ray 7.2.04		FRAMES
JOB #	<h1>THARP CABINET ORDER</h1>		
Sheet 1 of 6			
Description Trumbo new home		Address 6310 Choke Cherry, Loveland, CO	
Name David & Dena Trumbo		WOOD alder	SOFFIT
Phone 663-2446		STAIN G.P. / Buffet is painted	DOOR vermont
Contact David		EDGE none	DRAWER 5 piece std glide std. box
UPPERS 42	TOPS 3 cm granite	FINGERPULLS yes	
INSTALL tharp	DELIVER tharp	FLOORS wood	HINGE 1 1/4 custom

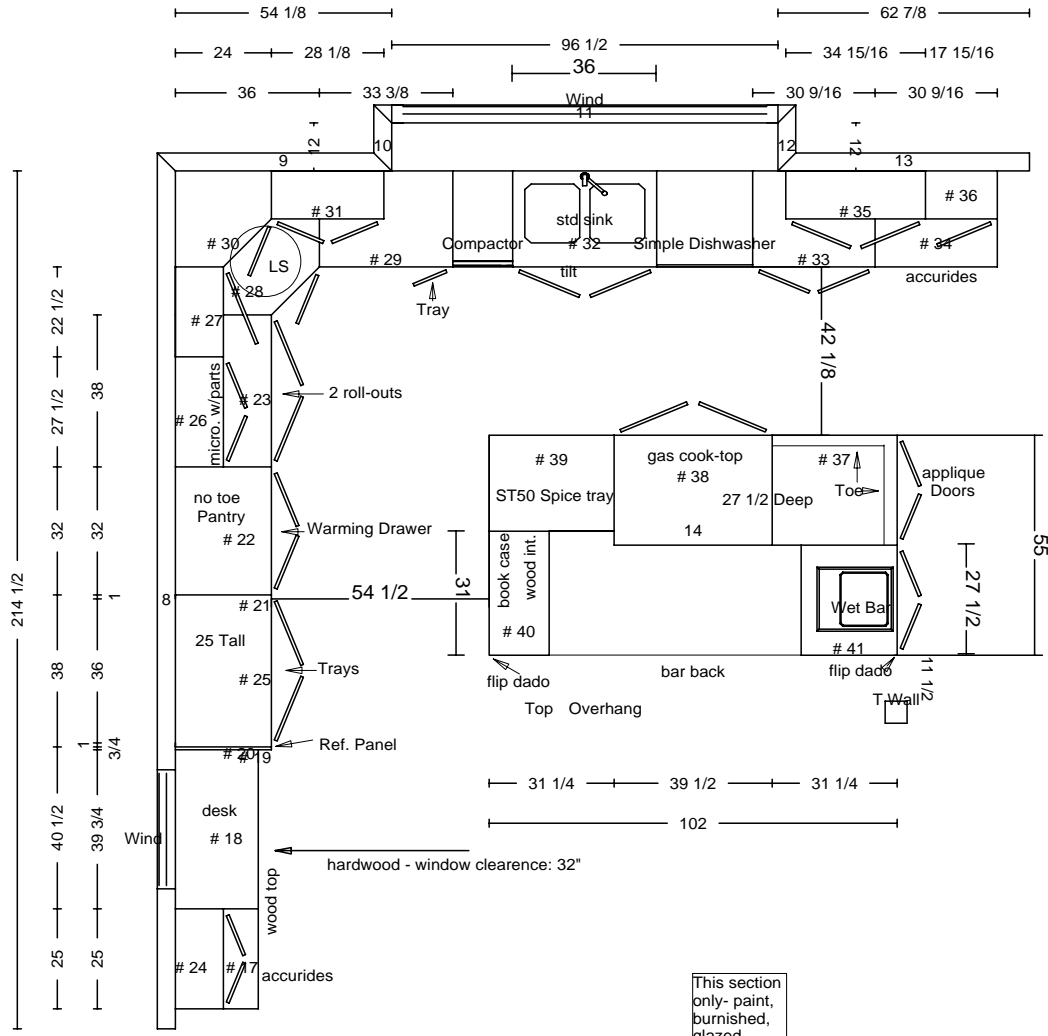

This section only- paint, burnished, glazed

crown molding only here

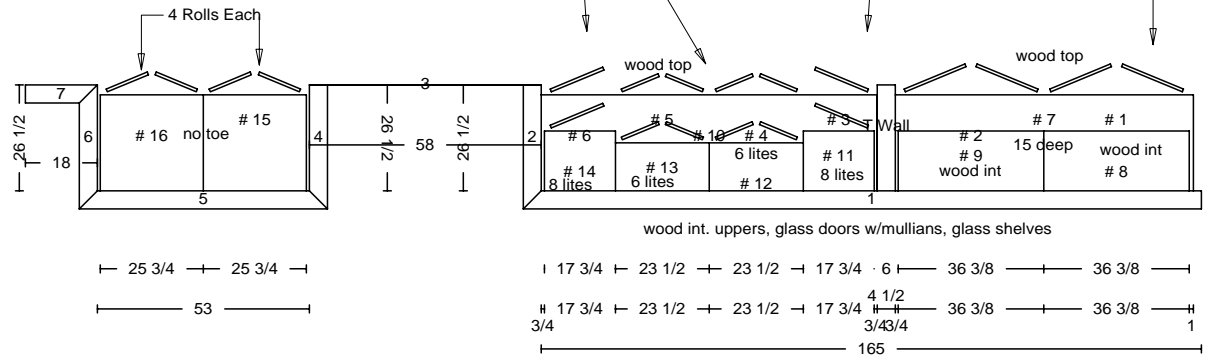

DATE		<h1>THARP CABINET ORDER</h1>	FRAMES	
JOB #				
Sheet 2 of 6				
Description Trumbo new home		Address 6310 Choke Cherry, Loveland, CO		
Name David & Dena Trumbo		WOOD	SOFFIT	
Phone 663-2446		STAIN	DOOR	
Contact David		EDGE	DRAWER	
UPPERS		TOPS	FINGERPULLS	
INSTALL	DELIVER		FLOORS	HINGE

$\frac{1}{2}$ | 36 $\frac{3}{8}$ | 36 $\frac{3}{8}$ | $\frac{4}{1}{2}$ | 17 $\frac{3}{4}$ | 23 $\frac{1}{2}$ | 23 $\frac{1}{2}$ | 17 $\frac{3}{4}$ | $\frac{3}{4}$
 $\frac{3}{4}$

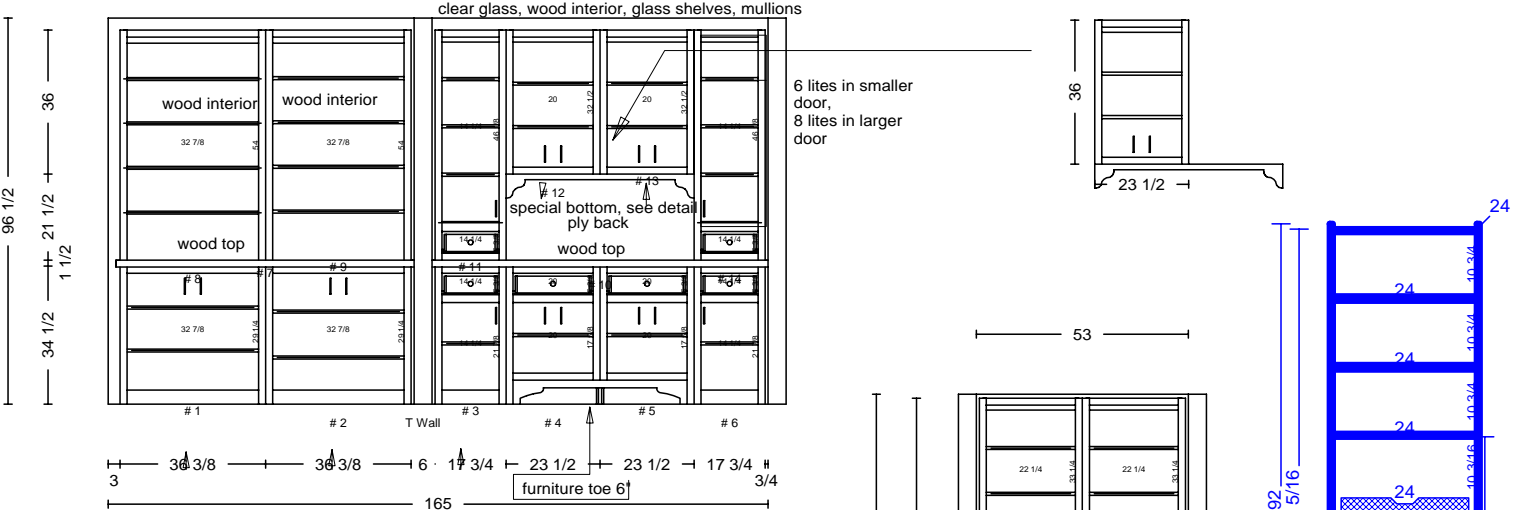

$\frac{3}{4}$ | 36 $\frac{3}{8}$ | 36 $\frac{3}{8}$ | 6 | 17 $\frac{3}{4}$ | 23 $\frac{1}{2}$ | 23 $\frac{1}{2}$ | 17 $\frac{3}{4}$ | $\frac{3}{4}$
 165 | furniture toe to 6

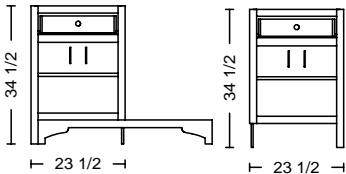

53

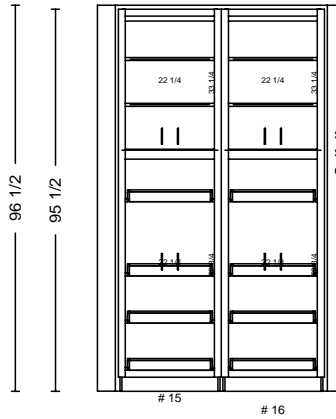

set roll-outs as shown...refer to detail drawing

$\frac{3}{4}$ | 25 $\frac{3}{4}$ | 25 $\frac{3}{4}$ | $\frac{3}{4}$

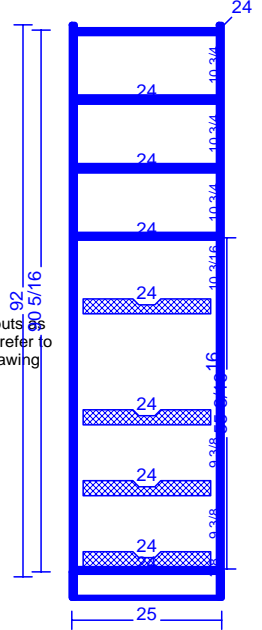

5 | 25 | 40 $\frac{1}{2}$ | 38 | 32 | 27 $\frac{1}{2}$ | 22 $\frac{1}{2}$ | 24 | 53 | 24 | 28 $\frac{1}{8}$ | 2

3 sides 1" filler-top, and both sides

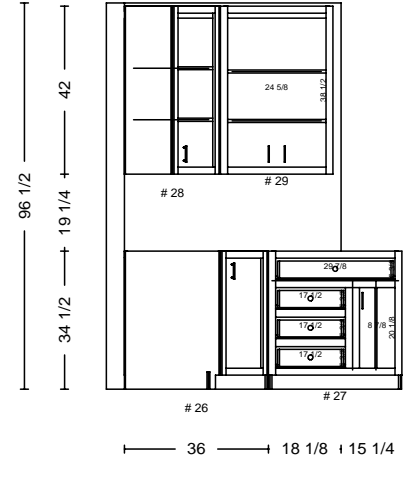
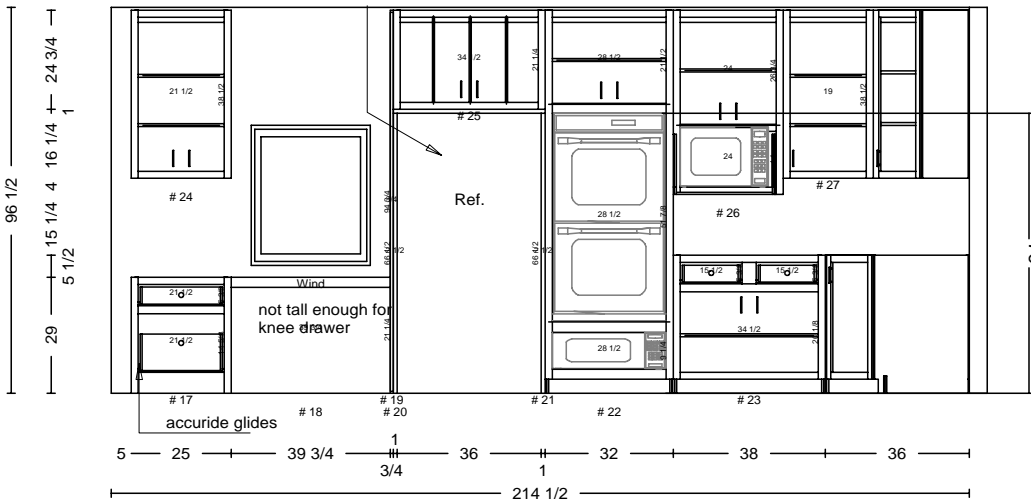

36 | 18 $\frac{1}{8}$ | 15 $\frac{1}{4}$
 54 $\frac{1}{8}$

DATE	<h1>THARP CABINET ORDER</h1>		FRAMES	
JOB #				
Sheet 3 of 6				
Description Trumbo new home		Address 6310 Choke Cherry, Loveland, CO		
Name David & Dena Trumbo		WOOD	SOFFIT	
Phone 663-2446		STAIN	DOOR	
Contact David		EDGE	DRAWER	
UPPERS		TOPS	FINGERPULLS	
INSTALL	DELIVER	FLOORS	HINGE	

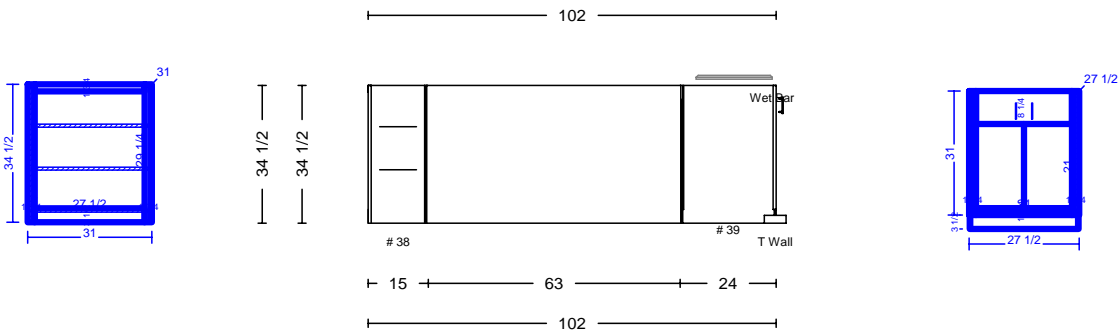
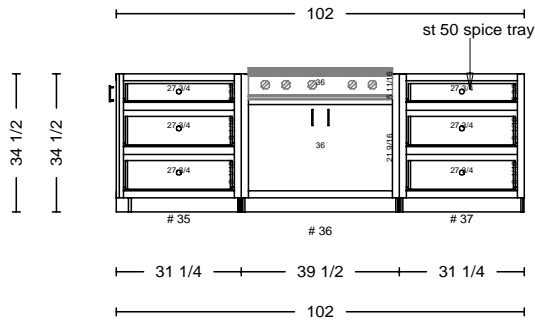
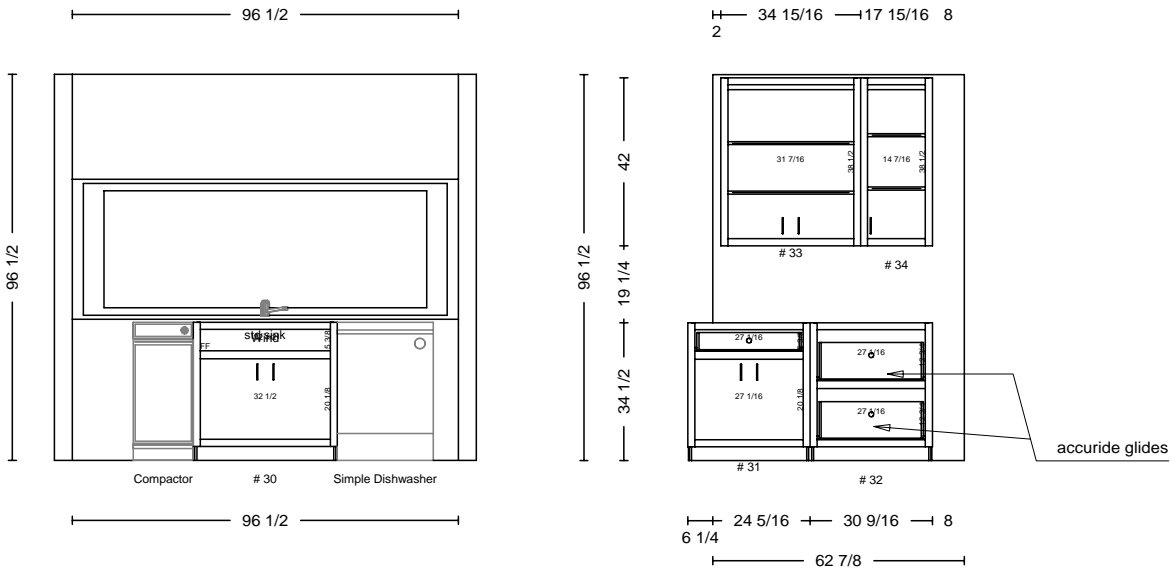

DATE	<h1>THARP CABINET ORDER</h1>		FRAMES	
JOB #				
Sheet 4 of 6				
Description Trumbo new home		Address 6310 Choke Cherry, Loveland, CO		
Name David & Dena Trumbo		WOOD	SOFFIT	
Phone 663-2446		STAIN	DOOR	
Contact David		EDGE	DRAWER	
UPPERS		TOPS	FINGERPULLS	
INSTALL	DELIVER	FLOORS	HINGE	

3 5/8 crown

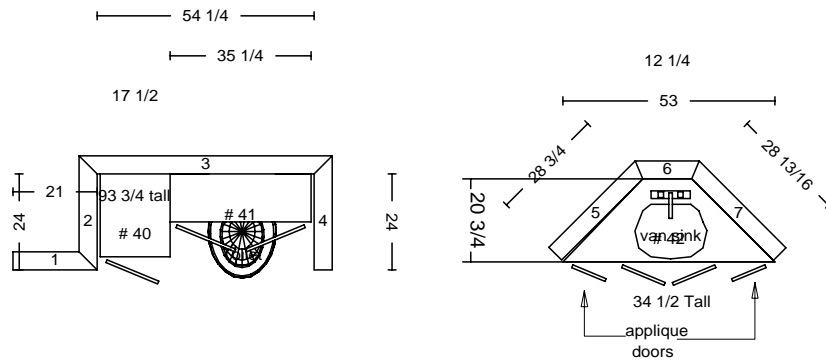

tops: hard surface

wood:	alder
door:	vermont
drawer:	5 piece
box:	std
glide:	std
crown:	yes std large
stain:	gp

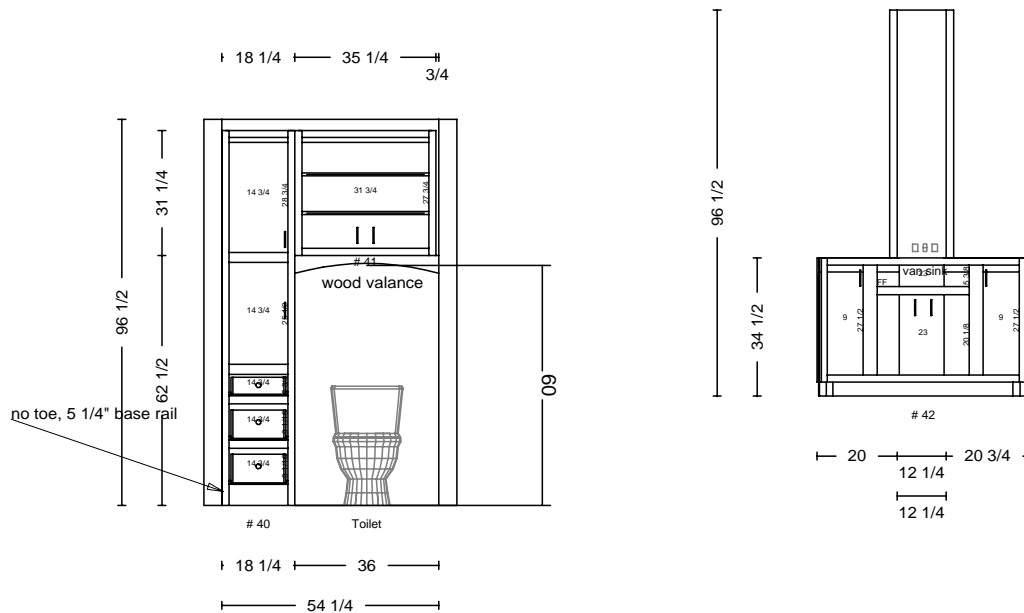
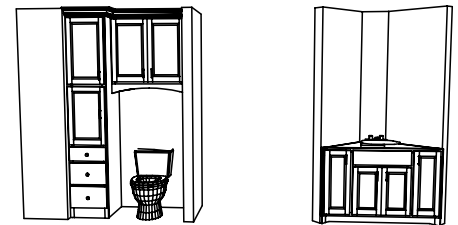

DATE	<h1>THARP CABINET ORDER</h1>			FRAMES	
JOB #					
Sheet 5 of 6					
Description Trumbo new home		Address 6310 Choke Cherry, Loveland, CO			
Name David & Dena Trumbo		WOOD	SOFFIT		
Phone 663-2446		STAIN	DOOR		
Contact David		EDGE	DRAWER		
UPPERS		TOPS		FINGERPULLS	
INSTALL	DELIVER		FLOORS		HINGE

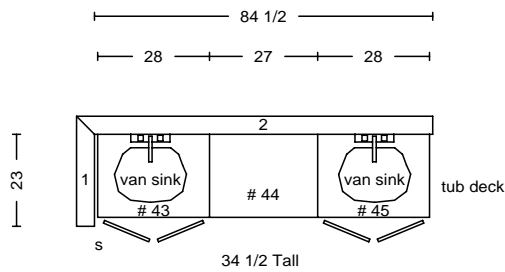

top: hard surface

wood:	alder
door:	vermont
drawer:	5 piece
box:	std
glide:	std
crown:	no
stain:	gp

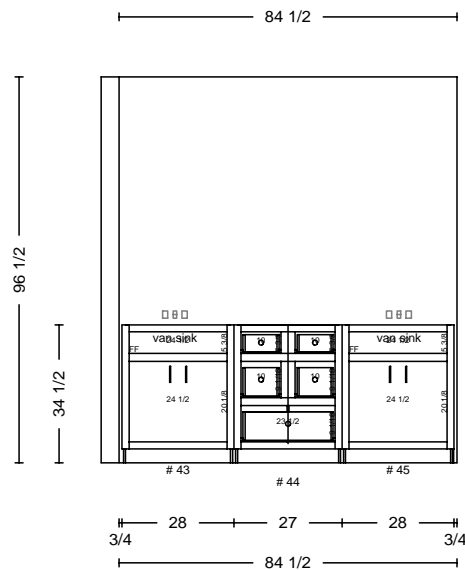

DATE	<h1>THARP CABINET ORDER</h1>			FRAMES	
JOB #					
Sheet 6 of 6					
Description Trumbo new home		Address 6310 Choke Cherry, Loveland, CO			
Name David & Dena Trumbo		WOOD	SOFFIT		
Phone 663-2446		STAIN	DOOR		
Contact David		EDGE	DRAWER		
UPPERS		TOPS		FINGERPULLS	
INSTALL	DELIVER		FLOORS		HINGE

