

| | | | |
|-----------------------------------|------------------------------|-------------------------------------|------------------------------|
| DATE | ray 7.1.04 | | FRAMES |
| JOB # | <h1>THARP CABINET ORDER</h1> | | |
| Sheet 1 of 6 | | | |
| Description Sarete Douillard Home | | Address 8235 N. 81 st, Longmont, CO | |
| Name Ginger & John Douillard | | WOOD beech | SOFFIT none 96 1/2 cathedral |
| Phone 720-530-0951 | | STAIN see each room | DOOR sheffield |
| Contact Tami | | EDGE none | DRAWER std...shaped edge |
| UPPERS 40" | TOPS see each room | FINGERPULLS yes | |
| INSTALL tharp | DELIVER tharp | FLOORS | HINGE 1 1/4 custom |

3 5/8 Crown

Light Rail

Stain-Natural

tile floor raise cabinet 1/2"

top: 3 cm granite

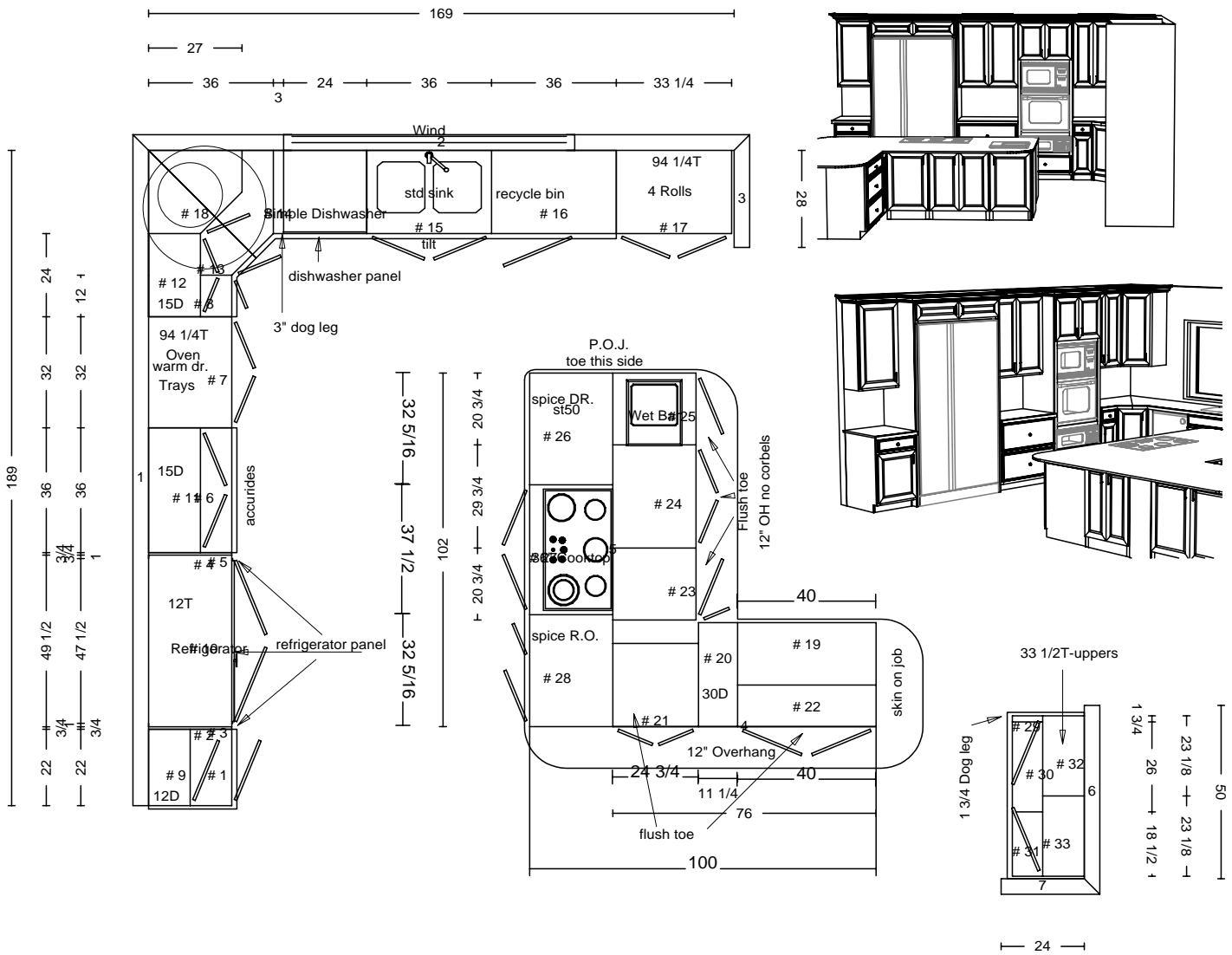

| | | | | |
|-----------------------------------|------------------------------|-------------------------------------|-------------|--|
| DATE | <h1>THARP CABINET ORDER</h1> | | FRAMES | |
| JOB # | | | | |
| Sheet 2 of 6 | | | | |
| Description Sarete Douillard Home | | Address 8235 N. 81 st, Longmont, CO | | |
| Name Ginger & John Douillard | | WOOD | SOFFIT | |
| Phone 720-530-0951 | | STAIN | DOOR | |
| Contact Tami | | EDGE | DRAWER | |
| UPPERS | | TOPS | FINGERPULLS | |
| INSTALL | DELIVER | FLOORS | HINGE | |

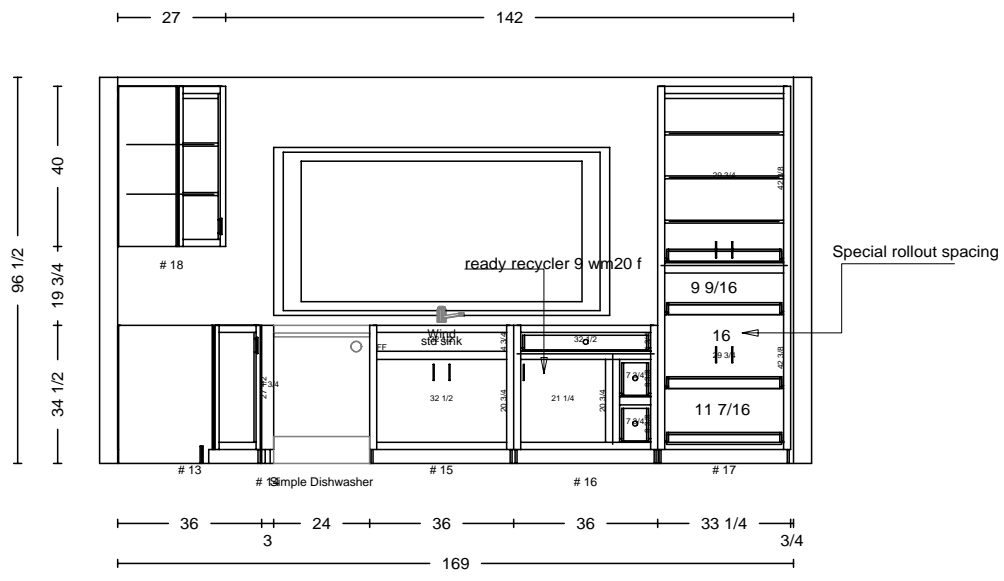
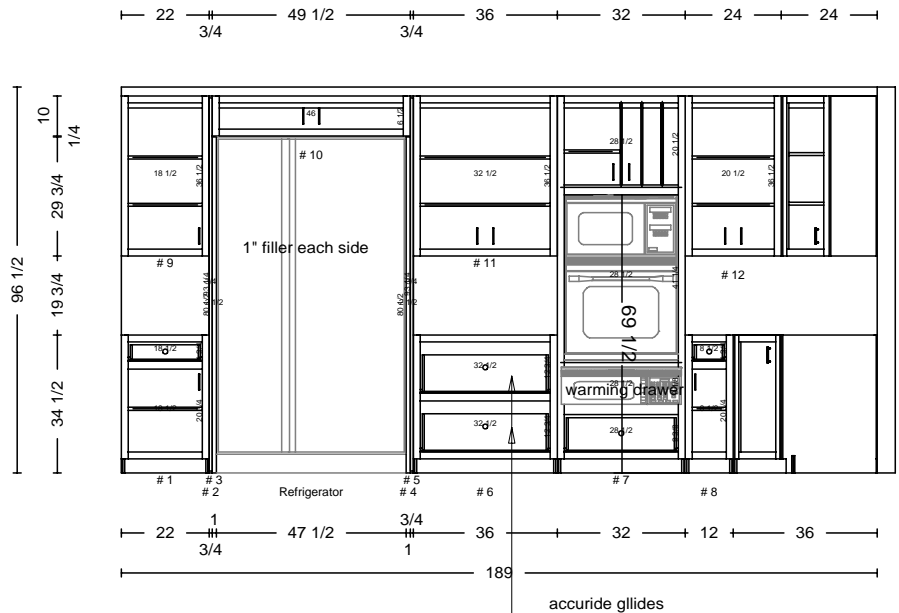

| | | | | |
|-----------------------------------|------------------------------|-------------------------------------|--------|-------------|
| DATE | <h1>THARP CABINET ORDER</h1> | | FRAMES | |
| JOB # | | | | |
| Sheet 3 of 6 | | | | |
| Description Sarete Douillard Home | | Address 8235 N. 81 st, Longmont, CO | | |
| Name Ginger & John Douillard | | WOOD | SOFFIT | |
| Phone 720-530-0951 | | STAIN | DOOR | |
| Contact Tami | | EDGE | DRAWER | |
| UPPERS | | TOPS | | FINGERPULLS |
| INSTALL | DELIVER | | HINGE | |

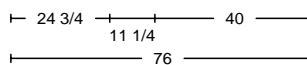
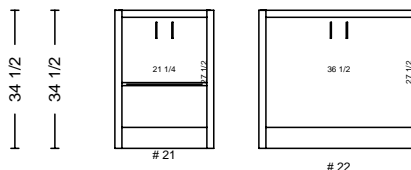
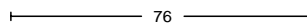
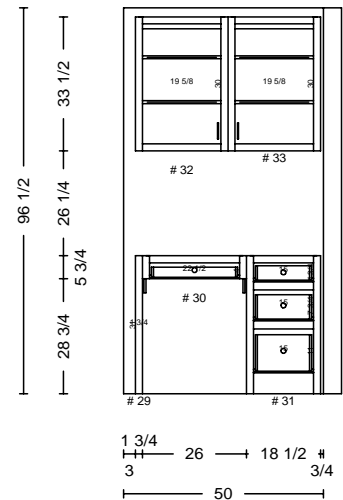
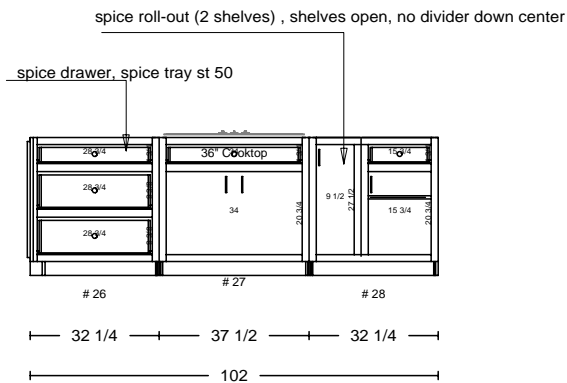
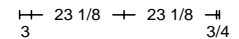
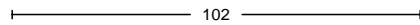
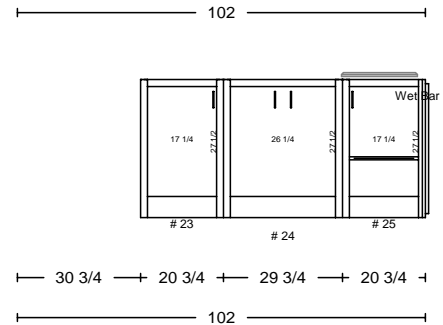
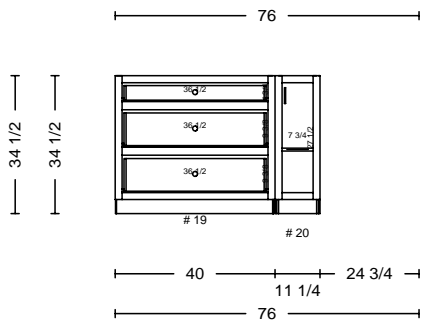

| | | | | |
|-----------------------------------|------------------------------|-------------------------------------|-------------|--|
| DATE | <h1>THARP CABINET ORDER</h1> | | FRAMES | |
| JOB # | | | | |
| Sheet 4 of 6 | | | | |
| Description Sarete Douillard Home | | Address 8235 N. 81 st, Longmont, CO | | |
| Name Ginger & John Douillard | | WOOD | SOFFIT | |
| Phone 720-530-0951 | | STAIN | DOOR | |
| Contact Tami | | EDGE | DRAWER | |
| UPPERS | | TOPS | FINGERPULLS | |
| INSTALL | DELIVER | FLOORS | HINGE | |

Stain-Natural
top: 3 cm granite

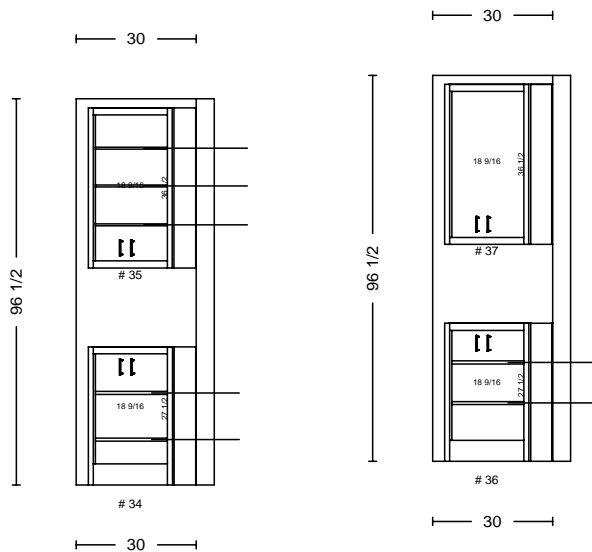
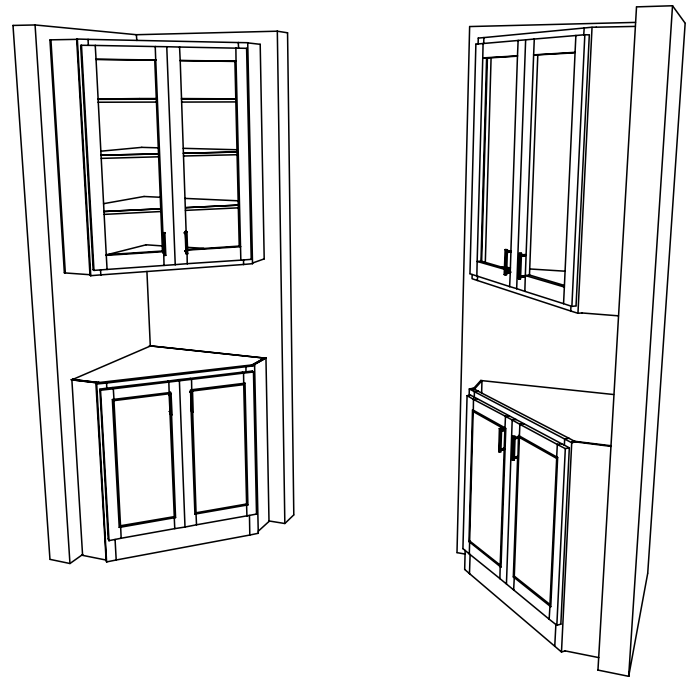
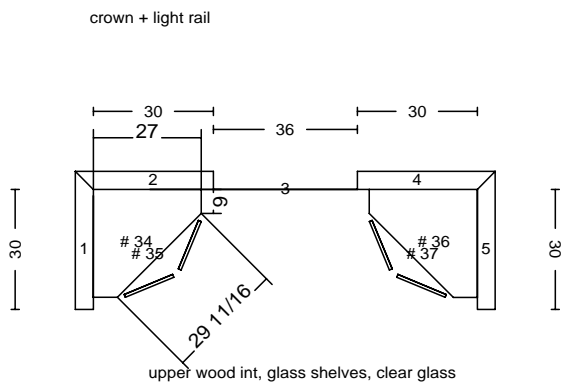

| | | | | |
|-----------------------------------|------------------------------|-------------------------------------|-------------|-------|
| DATE | <h1>THARP CABINET ORDER</h1> | | FRAMES | |
| JOB # | | | | |
| Sheet 5 of 6 | | | | |
| Description Sarete Douillard Home | | Address 8235 N. 81 st, Longmont, CO | | |
| Name Ginger & John Douillard | | WOOD | SOFFIT | |
| Phone 720-530-0951 | | STAIN | DOOR | |
| Contact Tami | | EDGE | DRAWER | |
| UPPERS | | TOPS | FINGERPULLS | |
| INSTALL | DELIVER | FLOORS | | HINGE |

3 5/8 Crown

Light Rail

Stain-Natural
Granite Tops

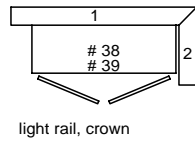
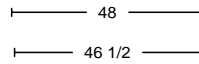
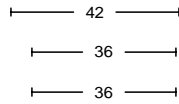

15

23

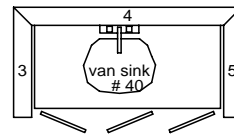

23

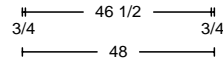
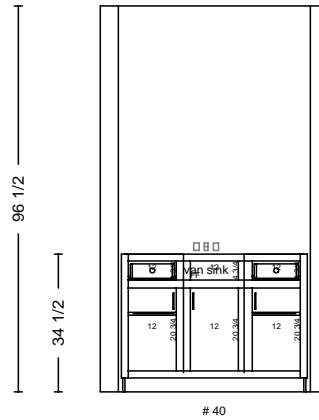
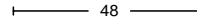
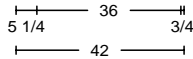
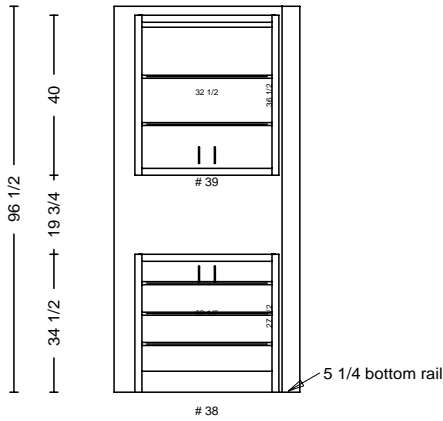
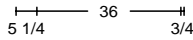

| | | | | | |
|-----------------------------------|------------------------------|-------------------------------------|--------|-------------|-------|
| DATE | <h1>THARP CABINET ORDER</h1> | | | FRAMES | |
| JOB # | | | | | |
| Sheet 6 of 6 | | | | | |
| Description Sarete Douillard Home | | Address 8235 N. 81 st, Longmont, CO | | | |
| Name Ginger & John Douillard | | WOOD | SOFFIT | | |
| Phone 720-530-0951 | | STAIN | DOOR | | |
| Contact Tami | | EDGE | DRAWER | | |
| UPPERS | | TOPS | | FINGERPULLS | |
| INSTALL | DELIVER | | FLOORS | | HINGE |

Stain-White Wash

Marble Tops

3 5/8 Crown

