

|              |                              |        |
|--------------|------------------------------|--------|
| DATE         | <h1>THARP CABINET ORDER</h1> | FRAMES |
| JOB #        |                              |        |
| Sheet 1 of 6 |                              |        |

|                                       |             |  |             |
|---------------------------------------|-------------|--|-------------|
| Description Peterson Winter Park home |             | Address 650 Elk Trail, Winter Park, CO |             |
| Name Brian Peterson                   |             | WOOD                                   | SOFFIT      |
| Phone 1-970-581-7597                  |             | STAIN                                  | DOOR        |
| Contact bruce                         |             | EDGE                                   | DRAWER      |
| UPPERS                                | TOPS        | FINGERPULLS                            |             |
| INSTALL Tharp                         | DELIVER Yes | FLOORS                                 | HINGE 1 1/4 |

See Each Page

tops: 3cm granite

|         |  |
|---------|--|
| wood:   | knotty alder                           |
| door:   | revere OUTSIDE EDGE (OE1)              |
| drawer: | 5 piece                                |
| box:    | dovetail                               |
| glide:  | under mount                            |
| crown:  | yes 3 5/8"                             |
| stain:  | golden pecan (heavy distress, burnish) |

RAISE CABINETS 1/2" FOR TILE FLOOR

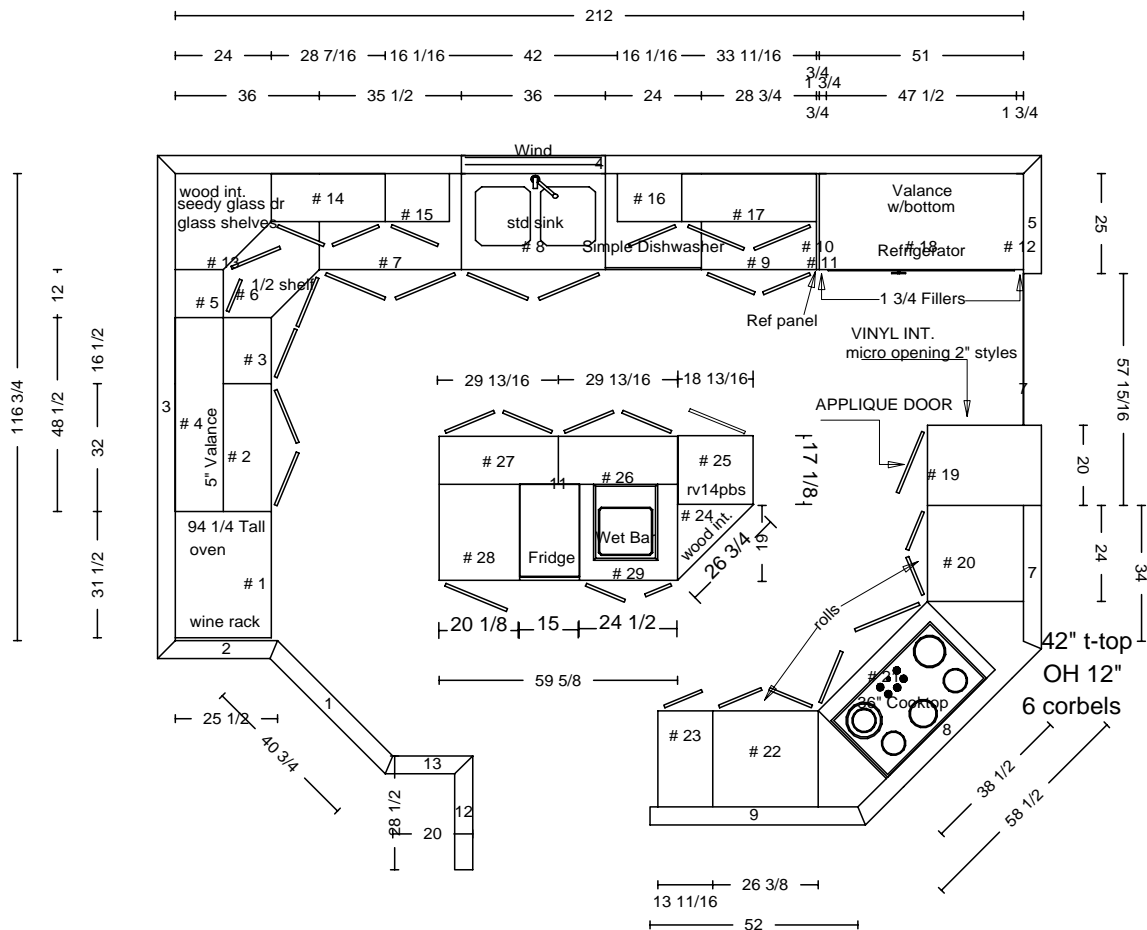

|                                       |                              |  |             |       |
|---------------------------------------|------------------------------|--|-------------|-------|
| DATE                                  | <h1>THARP CABINET ORDER</h1> |  | FRAMES      |       |
| JOB #                                 |                              |  |             |       |
| Sheet 2 of 6                          |                              |  |             |       |
| Description Peterson Winter Park home |                              | Address 650 Elk Trail, Winter Park, CO |             |       |
| Name Brian Peterson                   |                              | WOOD                                   | SOFFIT      |       |
| Phone 1-970-581-7597                  |                              | STAIN                                  | DOOR        |       |
| Contact bruce                         |                              | EDGE                                   | DRAWER      |       |
| UPPERS                                |                              | TOPS                                   | FINGERPULLS |       |
| INSTALL                               | DELIVER                      | FLOORS                                 |             | HINGE |

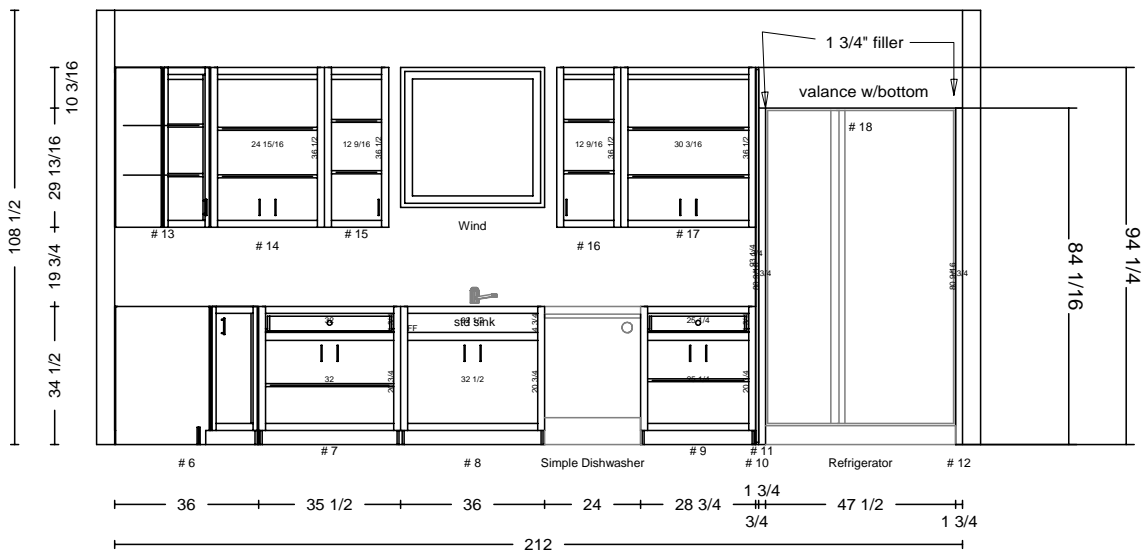
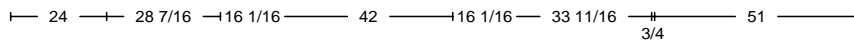
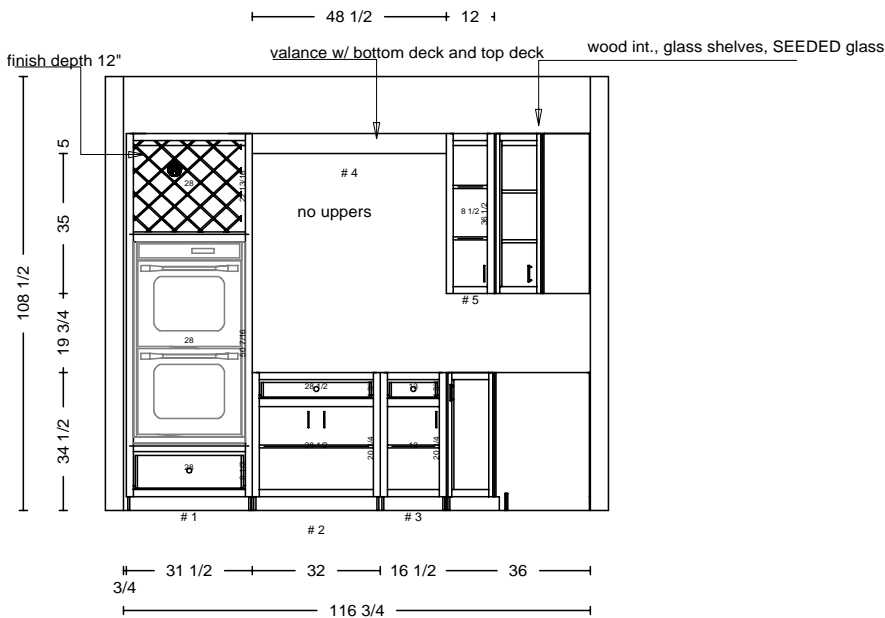

|                                       |                              |  |        |             |       |
|---------------------------------------|------------------------------|--|--------|-------------|-------|
| DATE                                  | <h1>THARP CABINET ORDER</h1> |  |        | FRAMES      |       |
| JOB #                                 |                              |  |        |             |       |
| Sheet 3 of 6                          |                              |  |        |             |       |
| Description Peterson Winter Park home |                              | Address 650 Elk Trail, Winter Park, CO |        |             |       |
| Name Brian Peterson                   |                              | WOOD                                   | SOFFIT |             |       |
| Phone 1-970-581-7597                  |                              | STAIN                                  | DOOR   |             |       |
| Contact bruce                         |                              | EDGE                                   | DRAWER |             |       |
| UPPERS                                |                              | TOPS                                   |        | FINGERPULLS |       |
| INSTALL                               | DELIVER                      |  | FLOORS |             | HINGE |



|                                       |                              |  |             |  |
|---------------------------------------|------------------------------|--|-------------|--|
| DATE                                  | <h1>THARP CABINET ORDER</h1> |  | FRAMES      |  |
| JOB #                                 |                              |  |             |  |
| Sheet 4 of 6                          |                              |  |             |  |
| Description Peterson Winter Park home |                              | Address 650 Elk Trail, Winter Park, CO |             |  |
| Name Brian Peterson                   |                              | WOOD                                   | SOFFIT      |  |
| Phone 1-970-581-7597                  |                              | STAIN                                  | DOOR        |  |
| Contact bruce                         |                              | EDGE                                   | DRAWER      |  |
| UPPERS                                |                              | TOPS                                   | FINGERPULLS |  |
| INSTALL                               | DELIVER                      | FLOORS                                 | HINGE       |  |

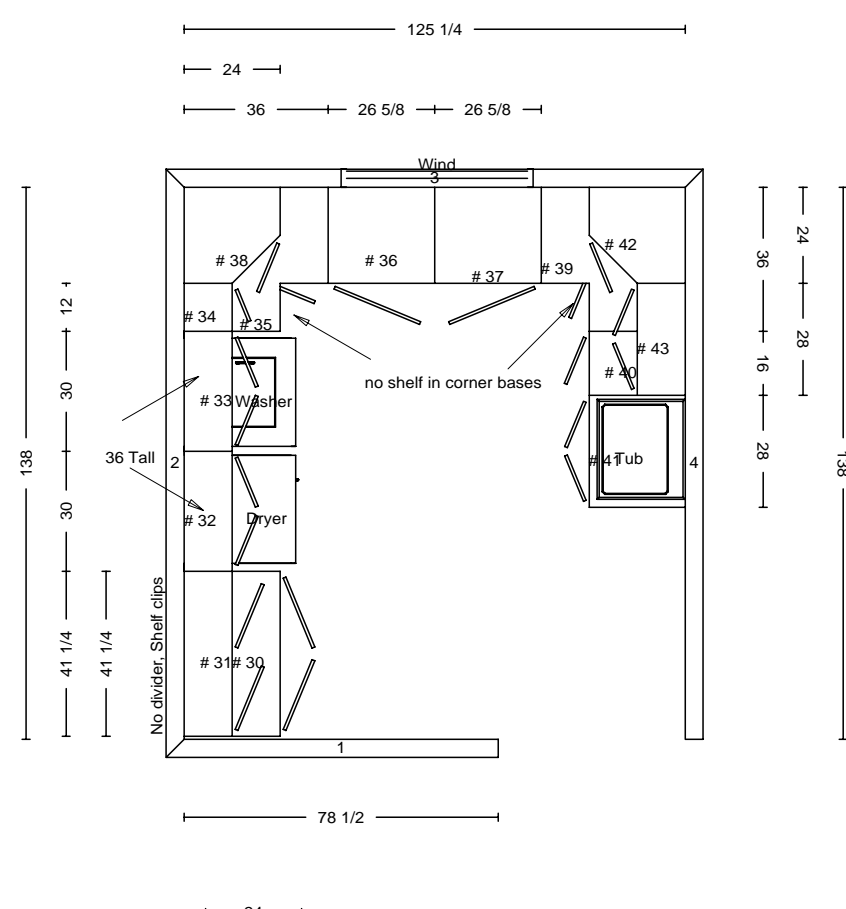

tops: tile, wood edge

|         |                            |
|---------|----------------------------|
| wood:   | knotty alder               |
| door:   | revere, OUTSIDE EDGE (OE1) |
| drawer: | std                        |
| box:    | std                        |
| glide:  | std                        |
| crown:  | no                         |
| stain:  | golden pecan               |

Dimensions: 24, 28

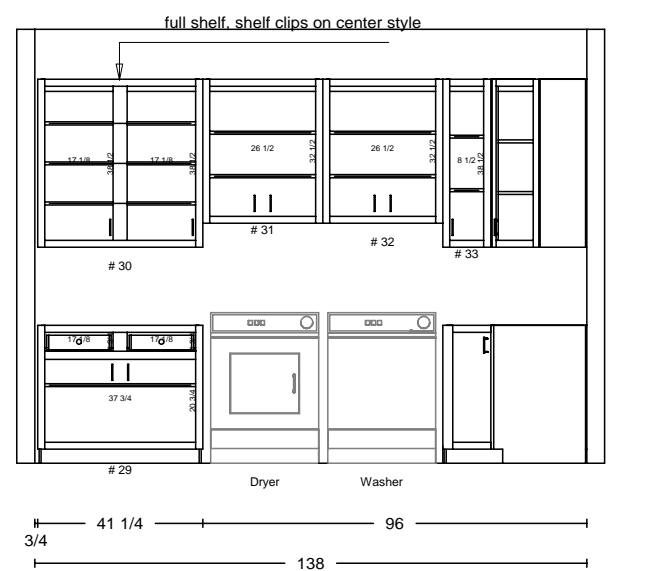
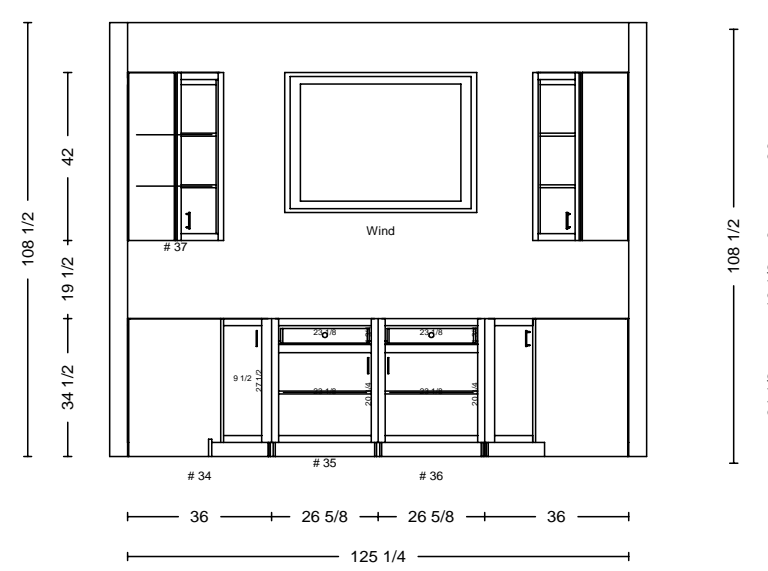

|              |                              |        |  |
|--------------|------------------------------|--------|--|
| DATE         | <h1>THARP CABINET ORDER</h1> | FRAMES |  |
| JOB #        |                              |        |  |
| Sheet 5 of 6 |                              |        |  |

|                                       |         |  |       |
|---------------------------------------|---------|--|-------|
| Description Peterson Winter Park home |         | Address 650 Elk Trail, Winter Park, CO |       |
| Name Brian Peterson                   | WOOD    | SOFFIT                                 |       |
| Phone 1-970-581-7597                  | STAIN   | DOOR                                   |       |
| Contact bruce                         | EDGE    | DRAWER                                 |       |
| UPPERS                                | TOPS    | FINGERPULLS                            |       |
| INSTALL                               | DELIVER | FLOORS                                 | HINGE |

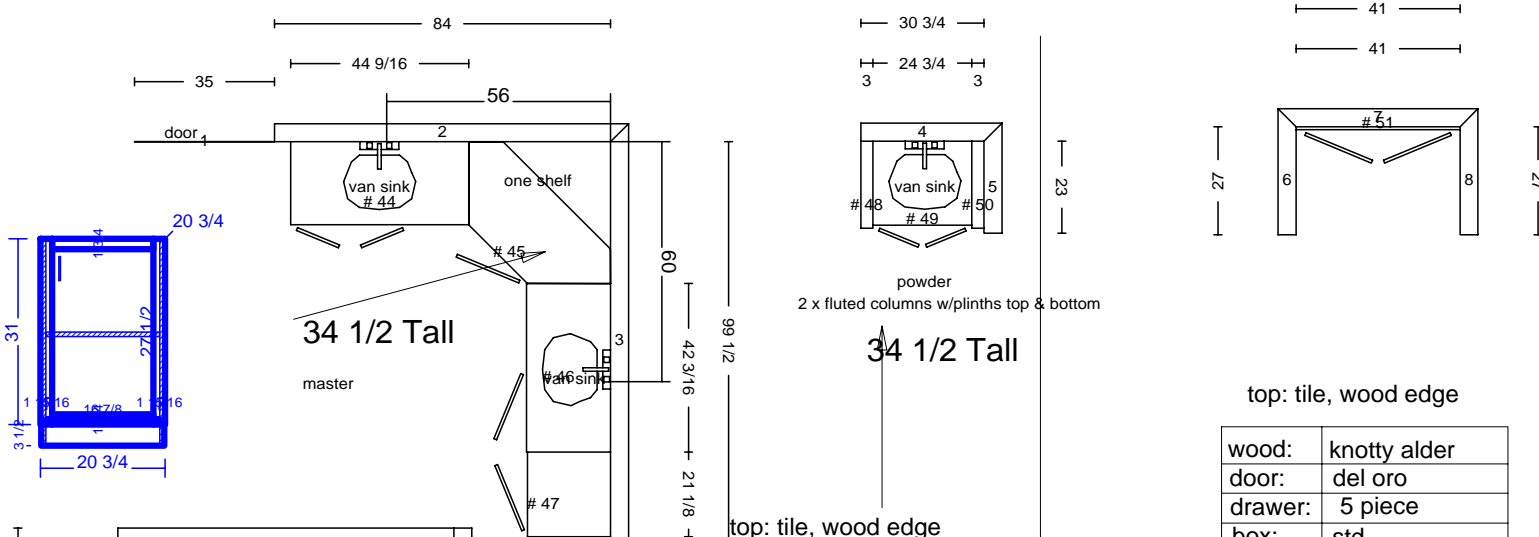

|         |                                       |
|---------|---------------------------------------|
| wood:   | knotty alder                          |
| door:   | revere Outside edge 0E1               |
| drawer: | 5 PIECE                               |
| box:    | std                                   |
| glide:  | std                                   |
| crown:  | no                                    |
| stain:  | golden pecan, heavy distress, Burnish |

|         |              |
|---------|--------------|
| wood:   | knotty alder |
| door:   | del oro      |
| drawer: | 5 piece      |
| box:    | std          |
| glide:  | std          |
| crown:  | none         |
| stain:  |              |

golden pecan, heavy distress, burnish

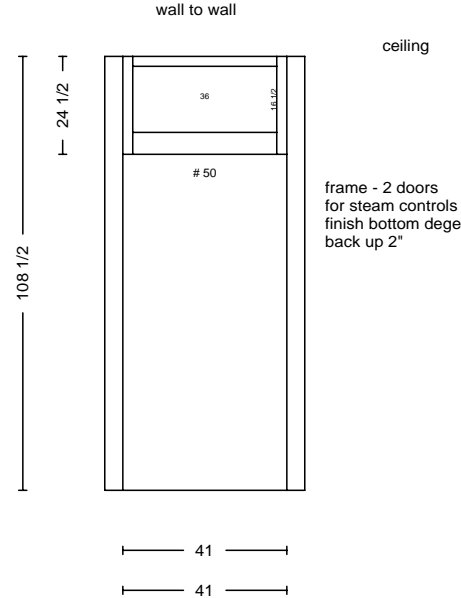
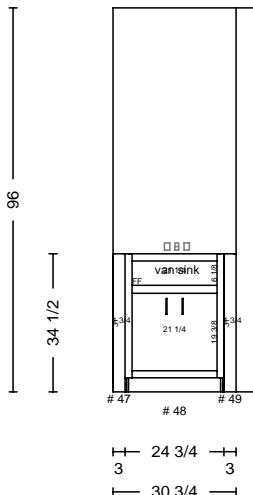
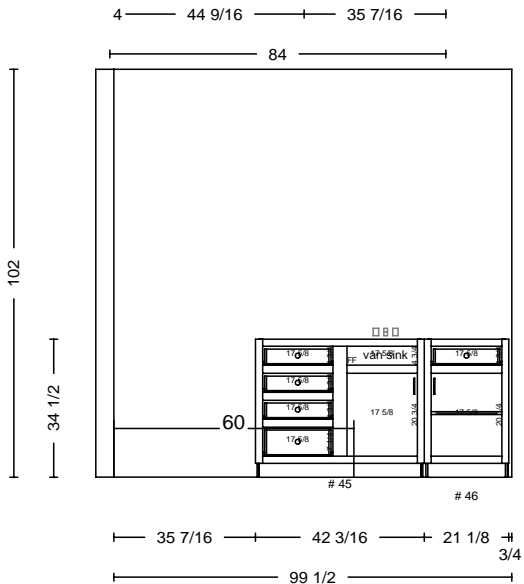
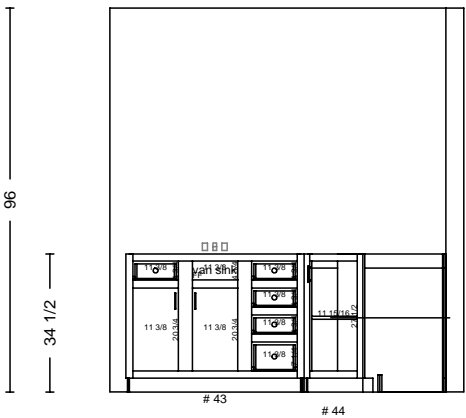

|                                       |                              |  |             |  |
|---------------------------------------|------------------------------|--|-------------|--|
| DATE                                  | <h1>THARP CABINET ORDER</h1> |  | FRAMES      |  |
| JOB #                                 |                              |  |             |  |
| Sheet 6 of 6                          |                              |  |             |  |
| Description Peterson Winter Park home |                              | Address 650 Elk Trail, Winter Park, CO |             |  |
| Name Brian Peterson                   |                              | WOOD                                   | SOFFIT      |  |
| Phone 1-970-581-7597                  |                              | STAIN                                  | DOOR        |  |
| Contact bruce                         |                              | EDGE                                   | DRAWER      |  |
| UPPERS                                |                              | TOPS                                   | FINGERPULLS |  |
| INSTALL                               | DELIVER                      | FLOORS                                 | HINGE       |  |

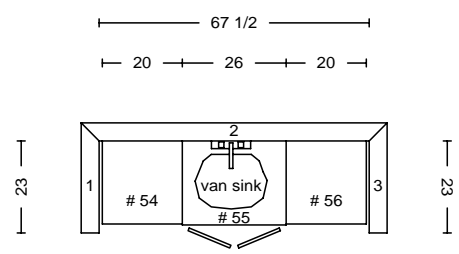
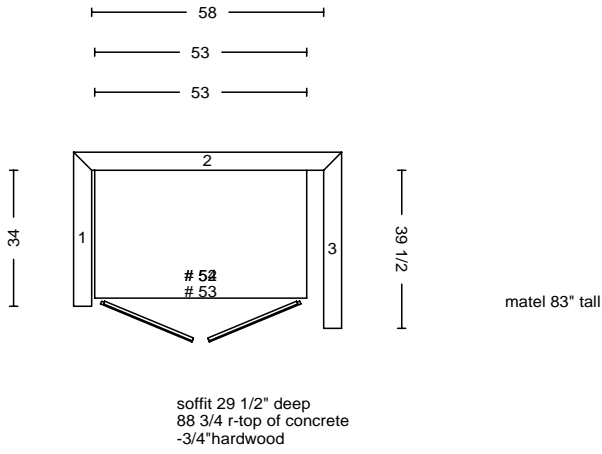

|         |                                       |
|---------|---------------------------------------|
| wood:   | KNOTTY ALDER                          |
| door:   | del oro                               |
| drawer: | n/a                                   |
| box:    | n/a                                   |
| glide:  | n/a                                   |
| crown:  | no                                    |
| stain:  | golden pecan, heavy distress, burnish |

top: tile, wood edge

|         |                            |
|---------|----------------------------|
| wood:   | knotty alder               |
| door:   | revere, OUTSIDE EDGE (OE1) |
| drawer: | STD                        |
| box:    | STD                        |
| glide:  | STD                        |
| crown:  | N/A                        |
| stain:  | GOLDEN PECAN               |

build as one unit in shop  
owner has been advised that doors will not retract full depth

