

DATE	9.13.04		FRAMES
JOB #	THARP CABINET ORDER		
Sheet 1 of 5			
Description Mosely construction new home		Address 1408 Catalpa Court, Fort Collins, CO	
Name John Moseley		WOOD knotty alder	SOFFIT 108 1/2 rock - sub
Phone 215-5085		STAIN cabot walnut	DOOR reve re
Contact John		EDGE none	DRAWER std, option 5 piece kit
UPPERS 3 5/8 Crown	TOPS granite/ tile	FINGERPULLS no	
INSTALL 20% flat finish	DELIVER tharp	FLOORS hardwood	HINGE 1 1/4 custom

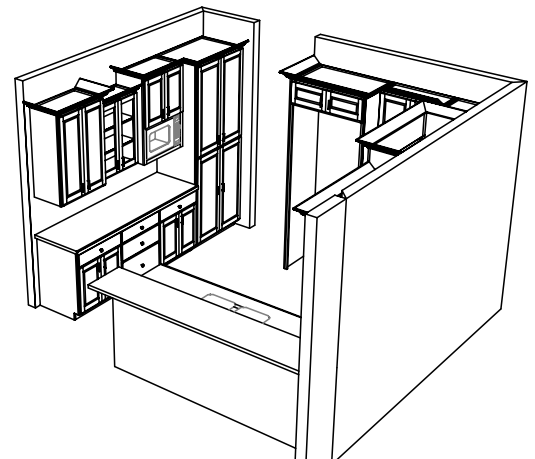

DATE	<h1>THARP CABINET ORDER</h1>			FRAMES	
JOB #					
Sheet 3 of 5					
Description Mosely construction new home		Address 1408 Catalpa Court, Fort Collins, CO			
Name John Moseley		WOOD	SOFFIT		
Phone 215-5085		STAIN	DOOR		
Contact John		EDGE	DRAWER		
UPPERS		TOPS		FINGERPULLS	
INSTALL	DELIVER		FLOORS		HINGE

old laundry room

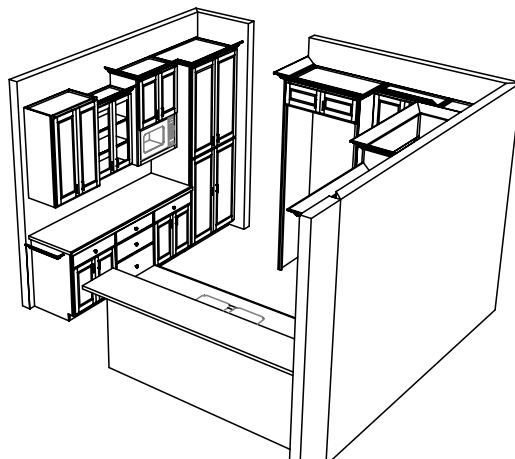
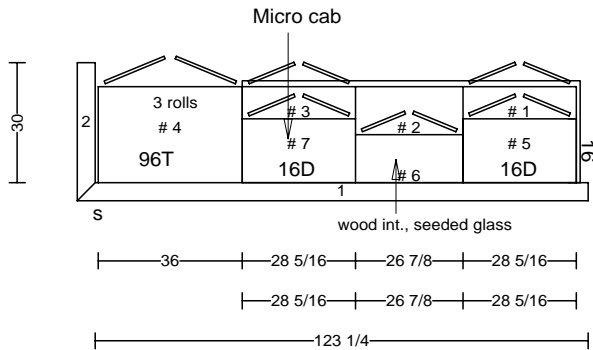
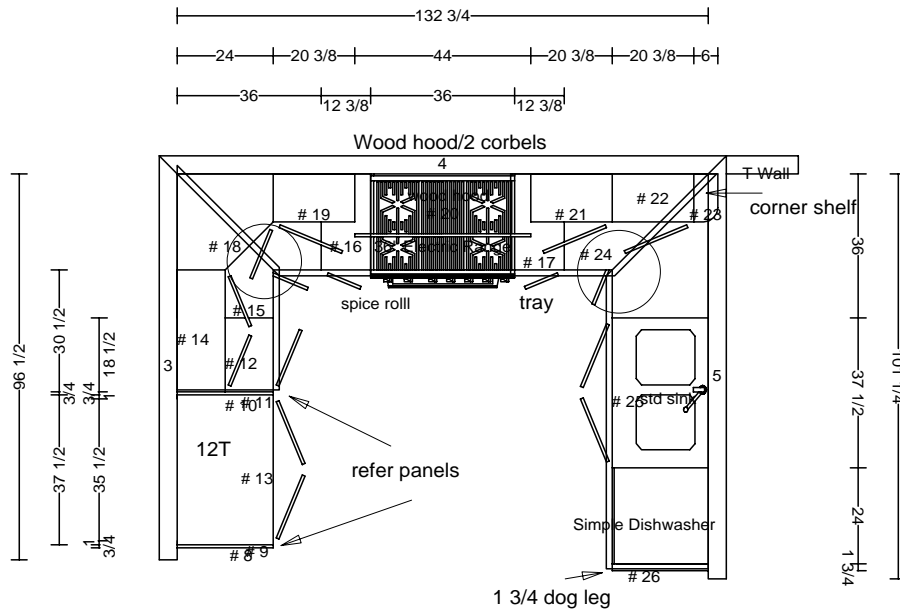
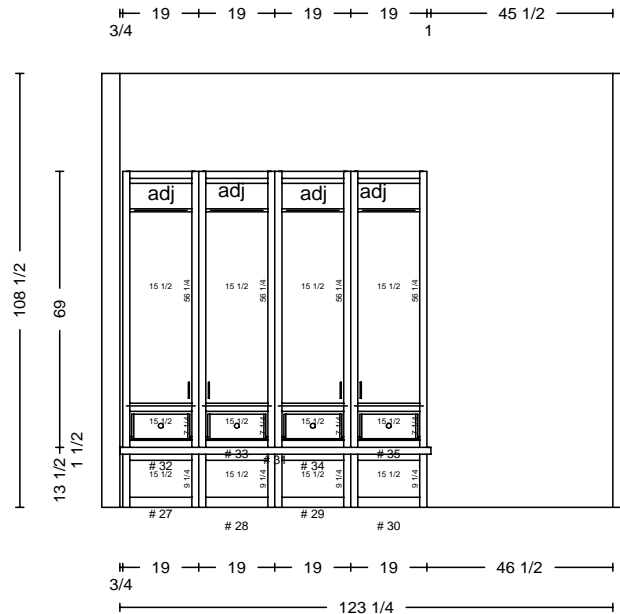
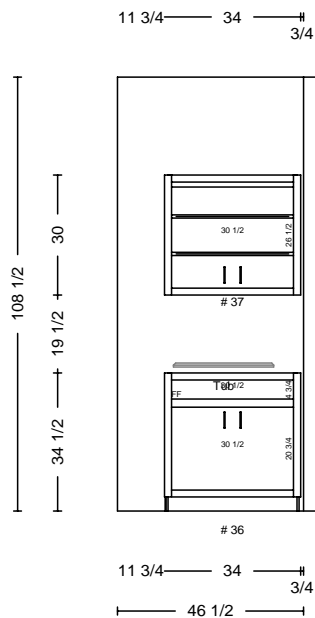
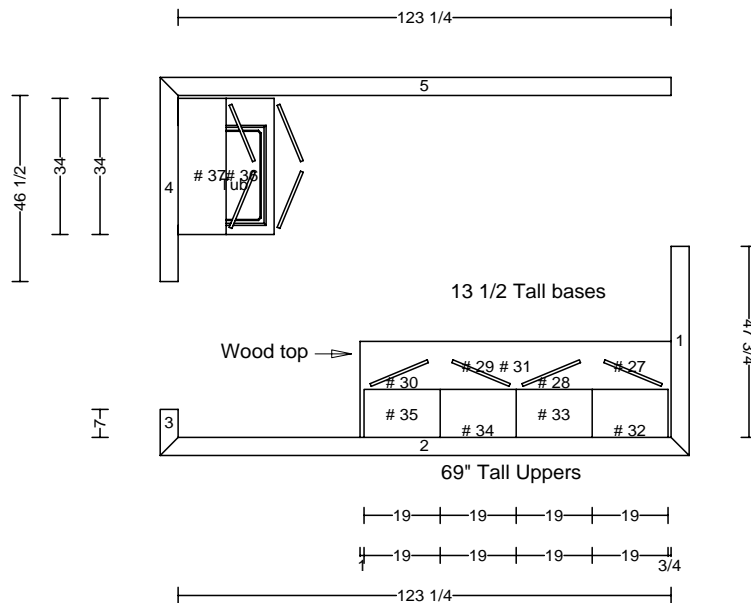

DATE	<h1>THARP CABINET ORDER</h1>		FRAMES	
JOB #				
Sheet 4 of 5				
Description Mosely construction new home		Address 1408 Catalpa Court, Fort Collins, CO		
Name John Moseley		WOOD	SOFFIT	
Phone 215-5085		STAIN	DOOR	
Contact John		EDGE	DRAWER	
UPPERS		TOPS	FINGERPULLS	
INSTALL	DELIVER	FLOORS	HINGE	

All vanities 34 1/2 Tall

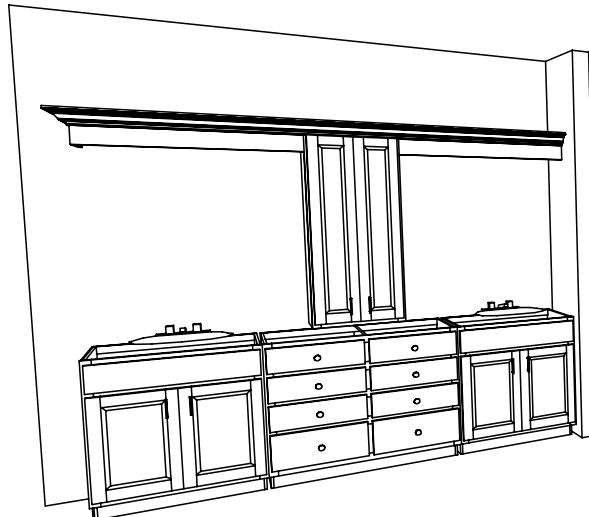
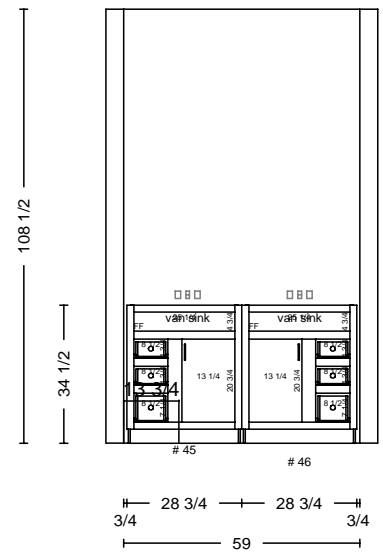
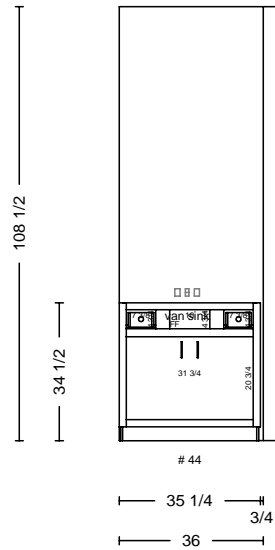
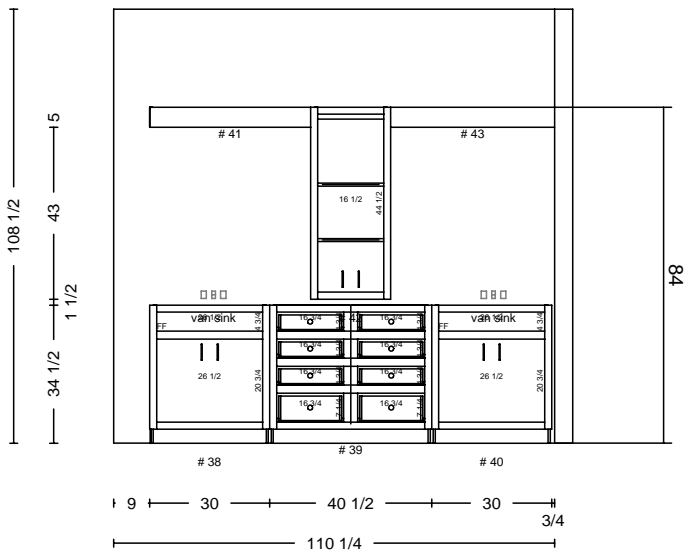
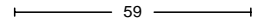
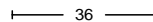
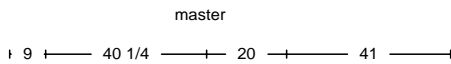
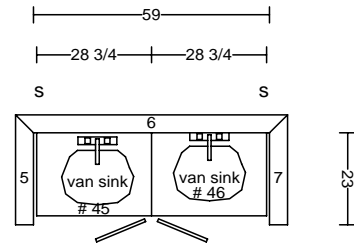
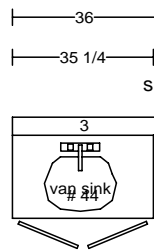
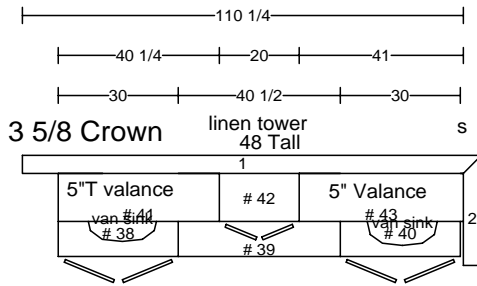

DATE	<h1>THARP CABINET ORDER</h1>			FRAMES	
JOB #					
Sheet 5 of 5					
Description Mosely construction new home		Address 1408 Catalpa Court, Fort Collins, CO			
Name John Moseley		WOOD	SOFFIT		
Phone 215-5085		STAIN	DOOR		
Contact John		EDGE	DRAWER		
UPPERS		TOPS		FINGERPULLS	
INSTALL	DELIVER		FLOORS		HINGE

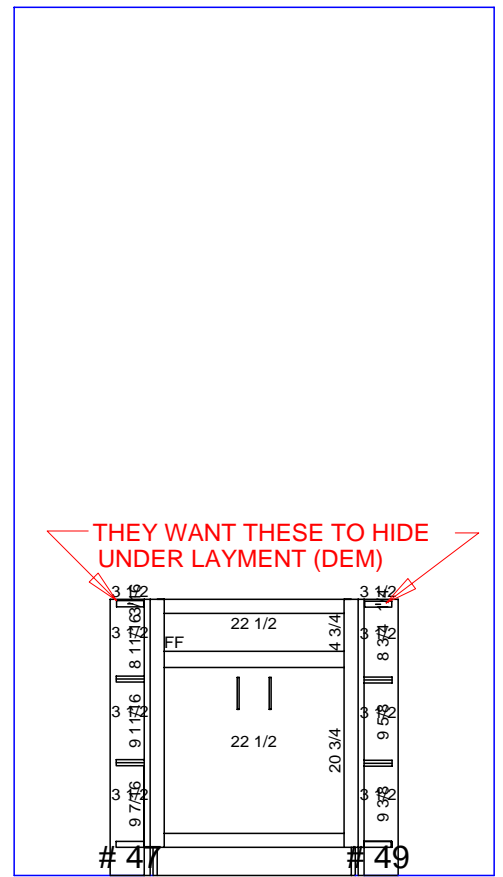
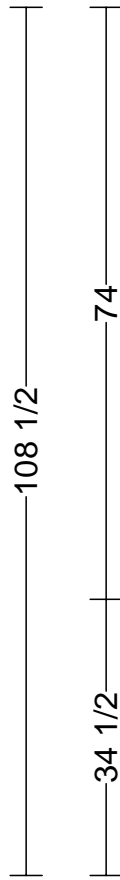
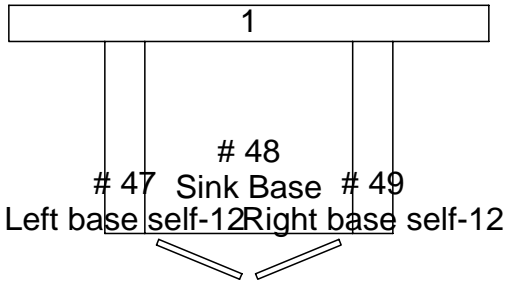
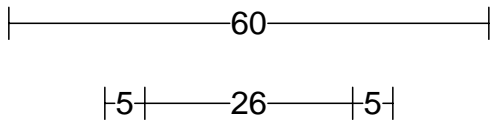

Left base self-12 Sink Base Right base self-12

