

DATE	ray 10.18.04	FRAMES
JOB #	<h1>THARP CABINET ORDER</h1>	
Sheet 1 of 7		

Description Jensen		Address 555 71st. Ave., Greeley, CO	
Name Shawn & Jill Shepherd		WOOD knotty alder	SOFFIT none 108
Phone 970-381-5599		STAIN nutmeg	DOOR upper: patriot, base: revere
Contact Jay		EDGE none	DRAWER standard
UPPERS 42 & 36	TOPS 3 cm granite	FINGERPULLS yes	
INSTALL self	DELIVER yes	FLOORS hardwood	HINGE 1 1/4 custom

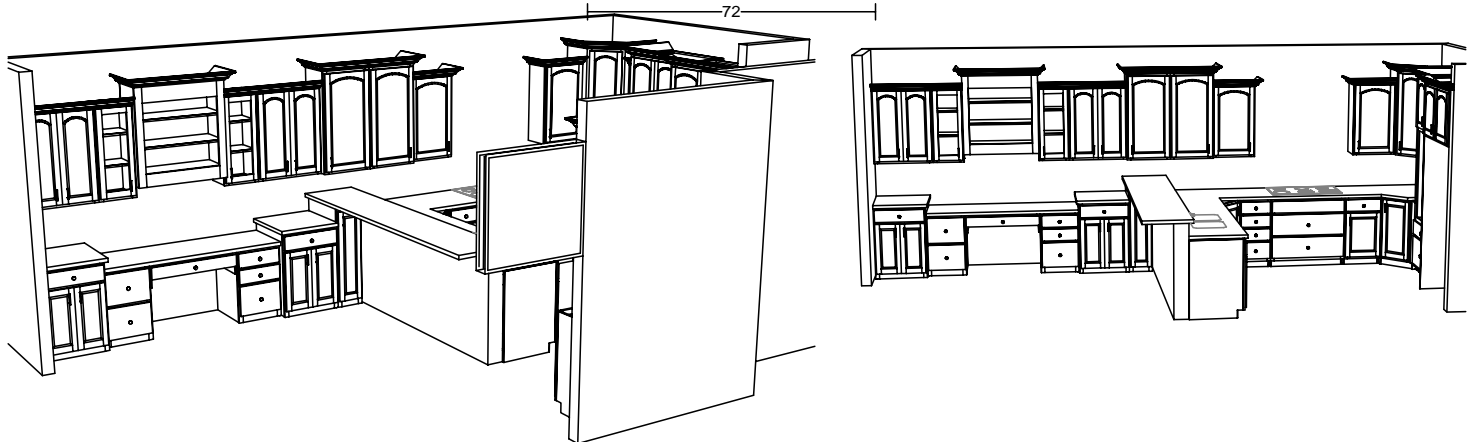

DATE	<h1>THARP CABINET ORDER</h1>			FRAMES	
JOB #					
Sheet 2 of 7					
Description Jensen		Address 555 71st. Ave., Greeley, CO			
Name Shawn & Jill Shepherd		WOOD	SOFFIT		
Phone 970-381-5599		STAIN	DOOR		
Contact Jay		EDGE	DRAWER		
UPPERS		TOPS		FINGERPULLS	
INSTALL	DELIVER		FLOORS		HINGE

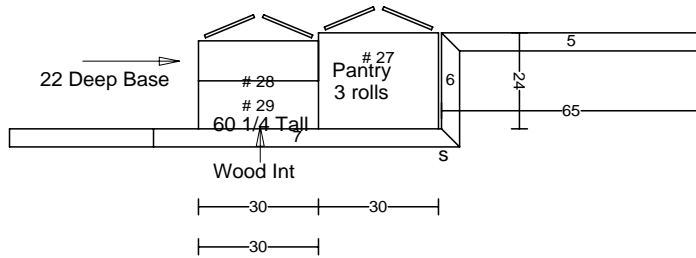
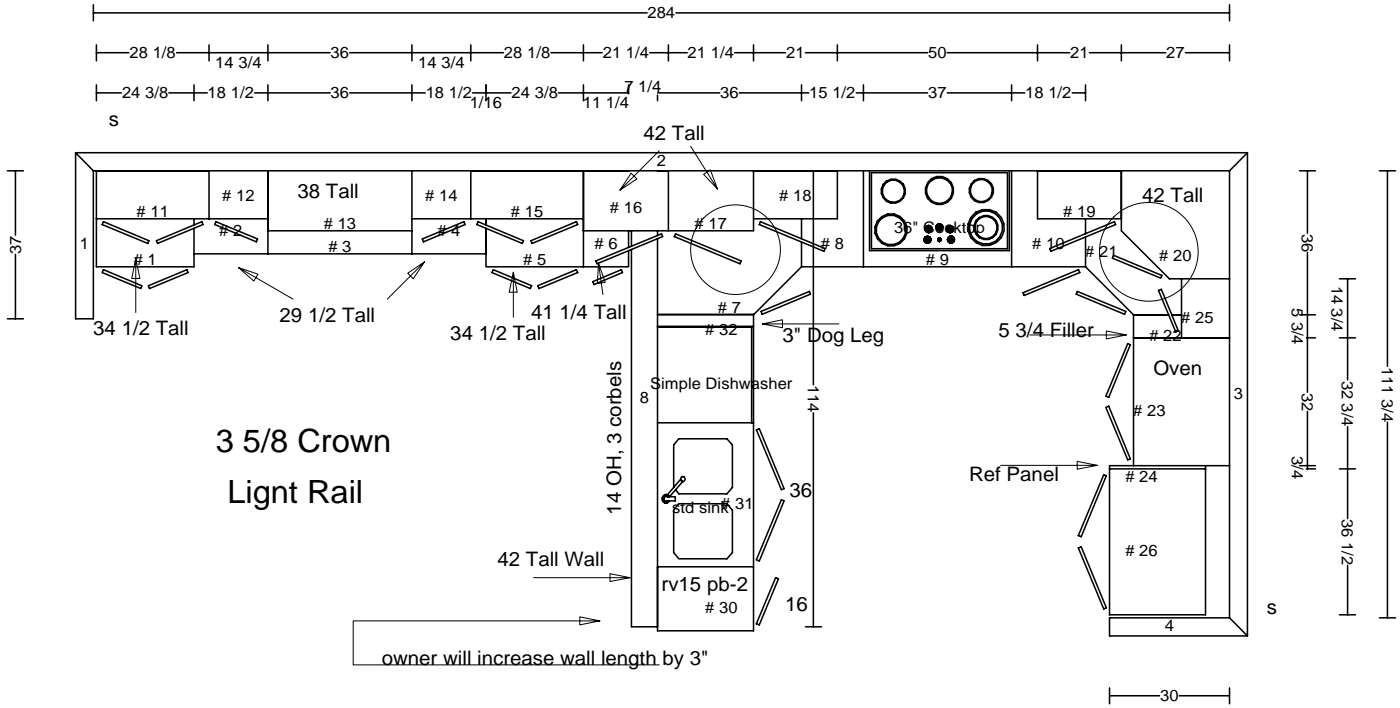
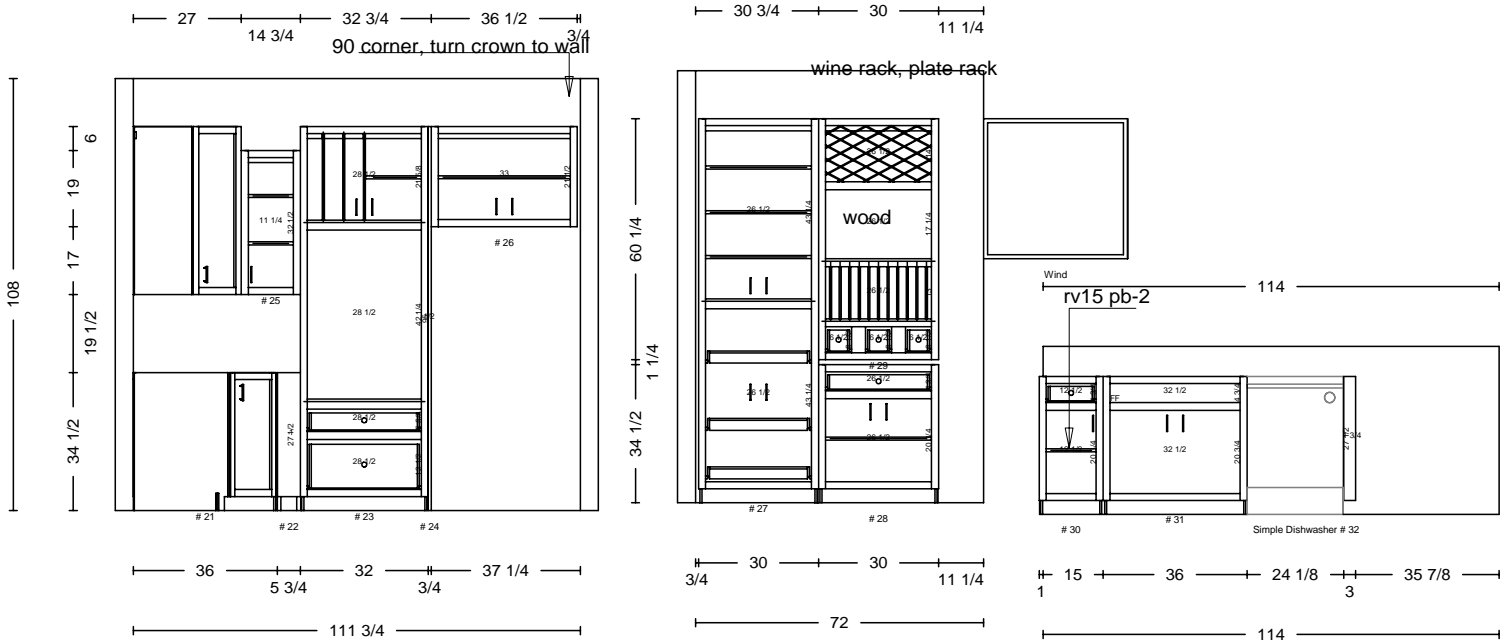
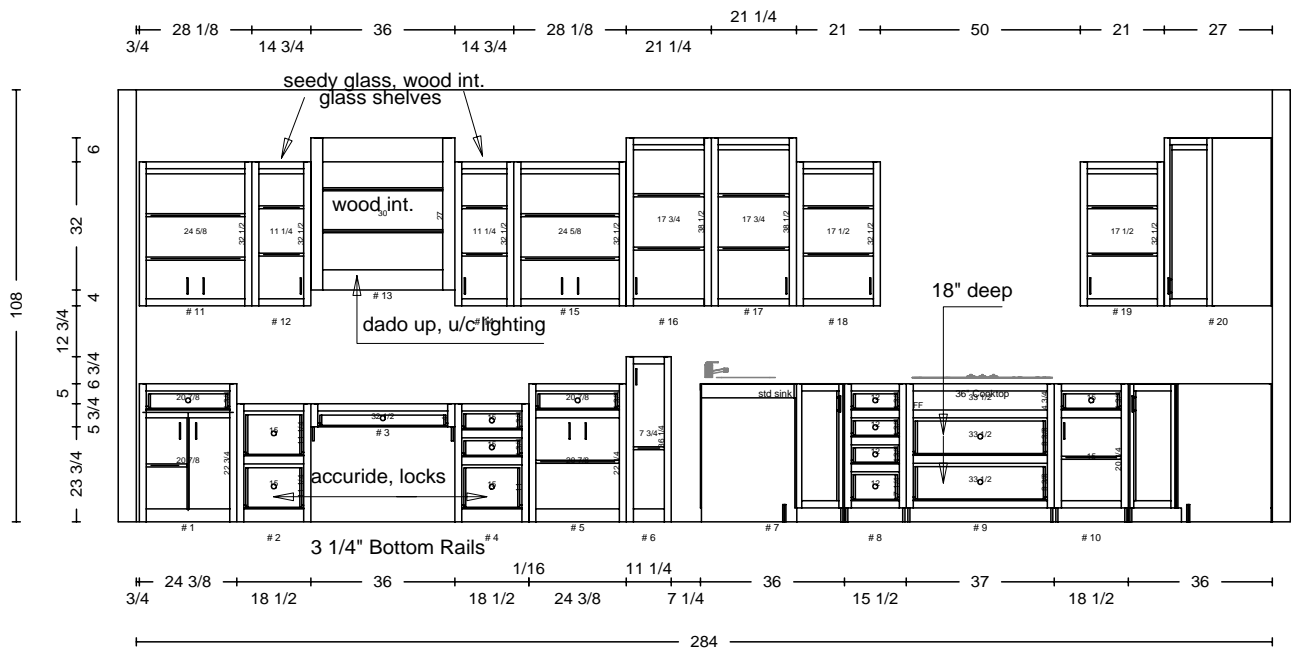

DATE	<h1>THARP CABINET ORDER</h1>			FRAMES
JOB #				
Sheet 3 of 7				
Description Jensen		Address 555 71st. Ave., Greeley, CO		
Name Shawn & Jill Shepherd		WOOD	SOFFIT	
Phone 970-381-5599		STAIN	DOOR	
Contact Jay		EDGE	DRAWER	
UPPERS	TOPS	FINGERPULLS		
INSTALL	DELIVER	FLOORS	HINGE	

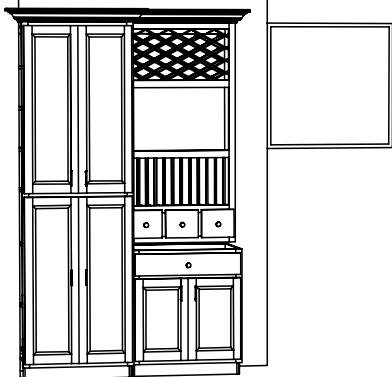
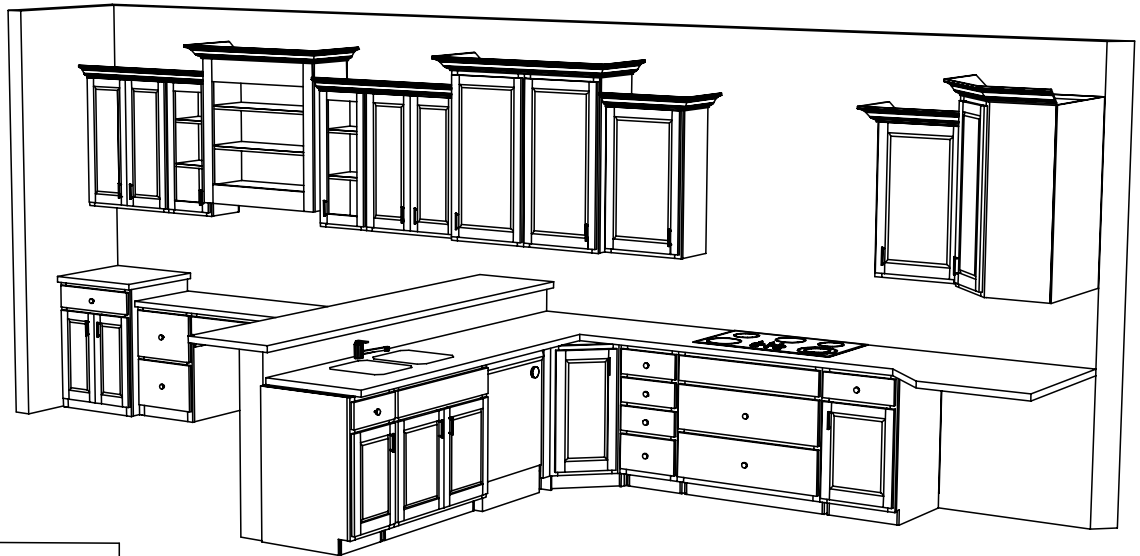
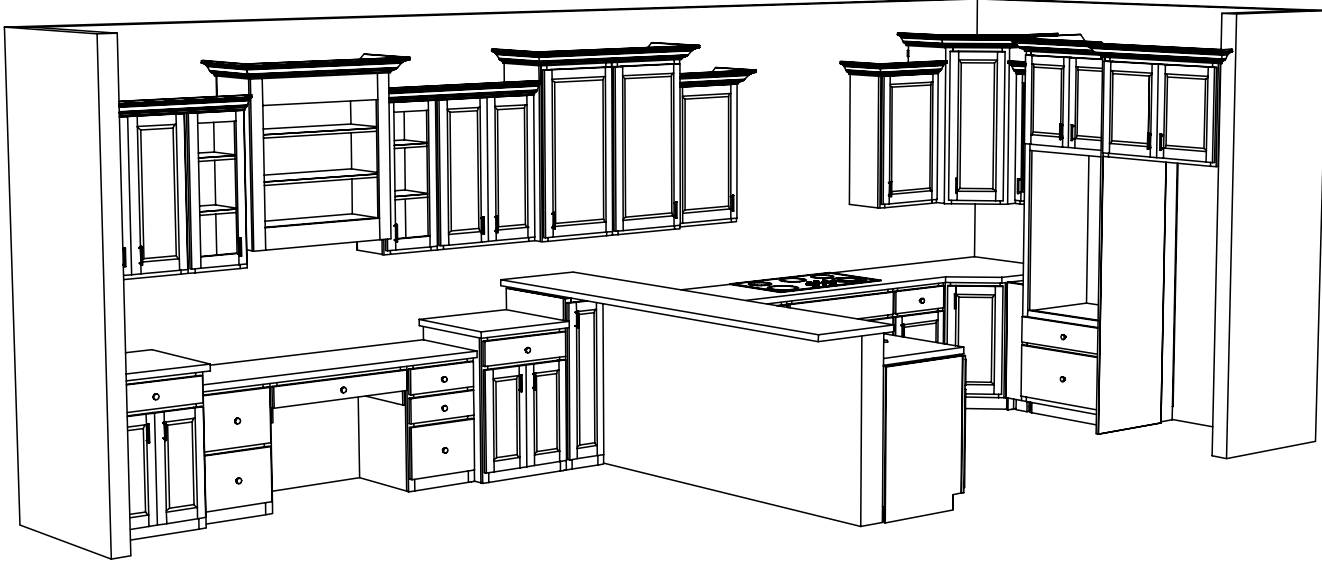

DATE	<h1>THARP CABINET ORDER</h1>			FRAMES	
JOB #					
Sheet 4 of 7					
Description Jensen		Address 555 71st. Ave., Greeley, CO			
Name Shawn & Jill Shepherd		WOOD	SOFFIT		
Phone 970-381-5599		STAIN	DOOR		
Contact Jay		EDGE	DRAWER		
UPPERS		TOPS		FINGERPULLS	
INSTALL	DELIVER		FLOORS		HINGE

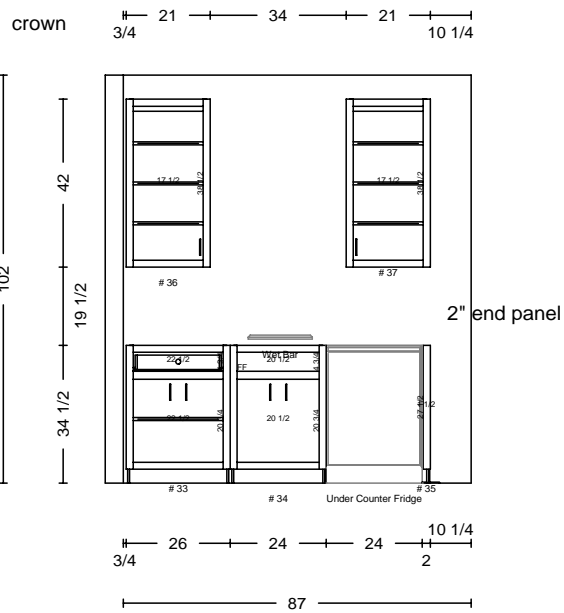
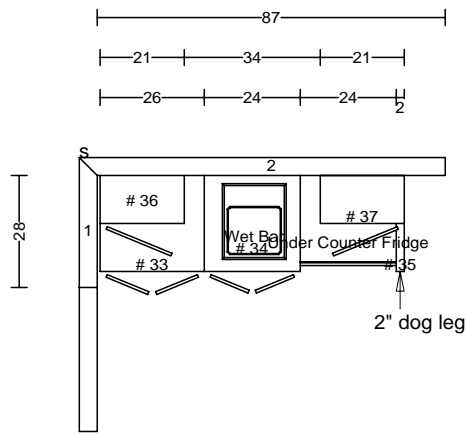

DATE	<h1>THARP CABINET ORDER</h1>		FRAMES	
JOB #				
Sheet 5 of 7				
Description Jensen		Address 555 71st. Ave., Greeley, CO		
Name Shawn & Jill Shepherd		WOOD	SOFFIT	
Phone 970-381-5599		STAIN	DOOR	
Contact Jay		EDGE	DRAWER	
UPPERS	TOPS		FINGERPULLS	
INSTALL	DELIVER	FLOORS		HINGE

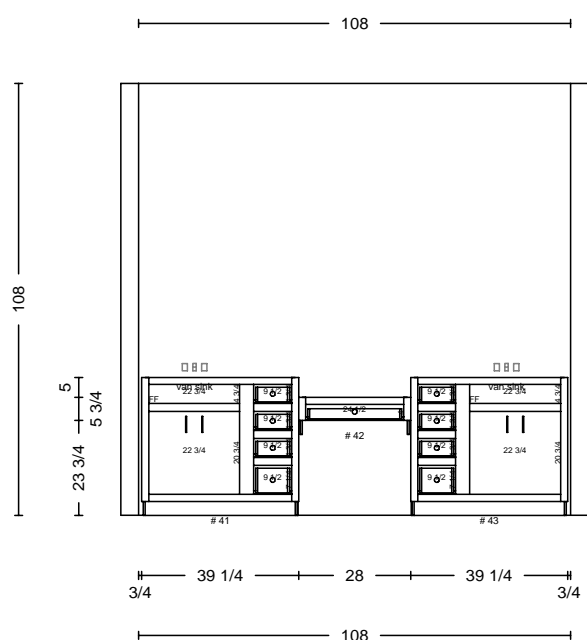
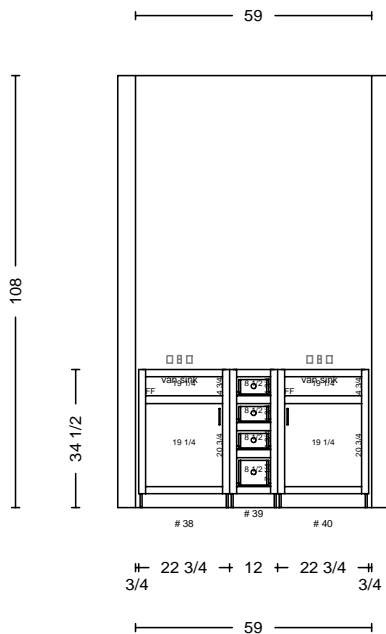
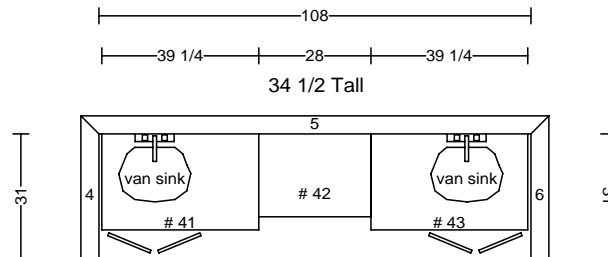
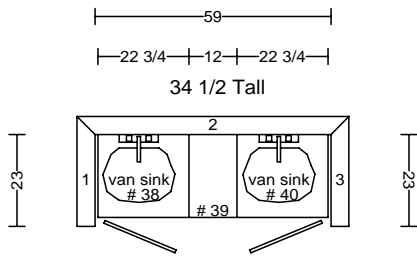

DATE	<h1>THARP CABINET ORDER</h1>		FRAMES	
JOB #				
Sheet 6 of 7				
Description Jensen		Address 555 71st. Ave., Greeley, CO		
Name Shawn & Jill Shepherd		WOOD	SOFFIT	
Phone 970-381-5599		STAIN	DOOR	
Contact Jay		EDGE	DRAWER	
UPPERS		TOPS		FINGERPULLS
INSTALL	DELIVER	FLOORS		HINGE

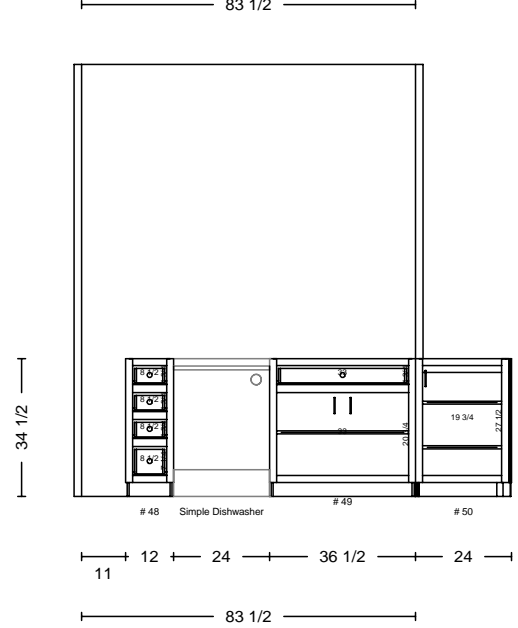
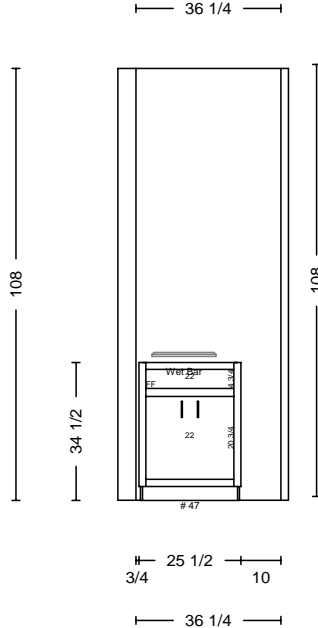
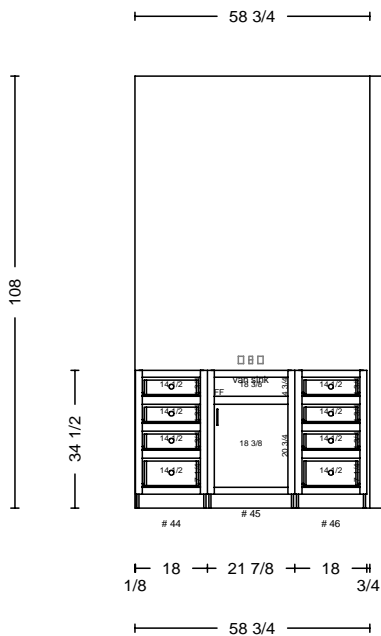
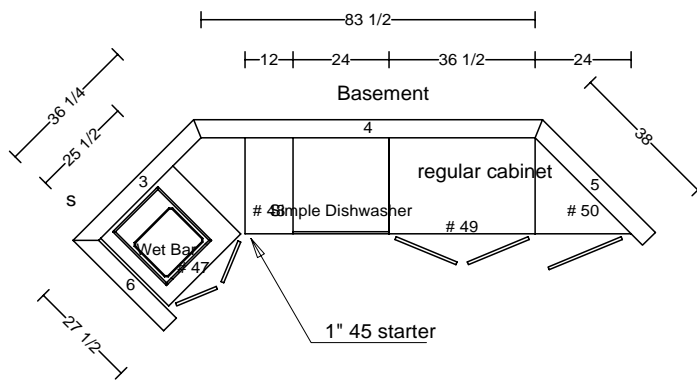
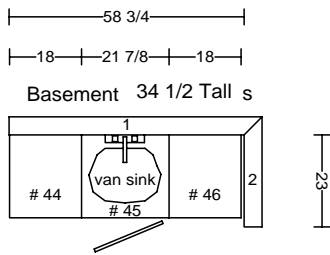

DATE	<h1>THARP CABINET ORDER</h1>			FRAMES	
JOB #					
Sheet 7 of 7					
Description Jensen		Address 555 71st. Ave., Greeley, CO			
Name Shawn & Jill Shepherd		WOOD	SOFFIT		
Phone 970-381-5599		STAIN	DOOR		
Contact Jay		EDGE	DRAWER		
UPPERS		TOPS		FINGERPULLS	
INSTALL	DELIVER		FLOORS		HINGE

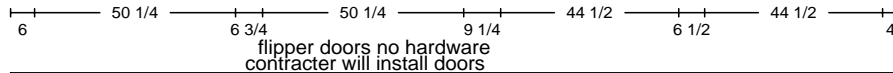
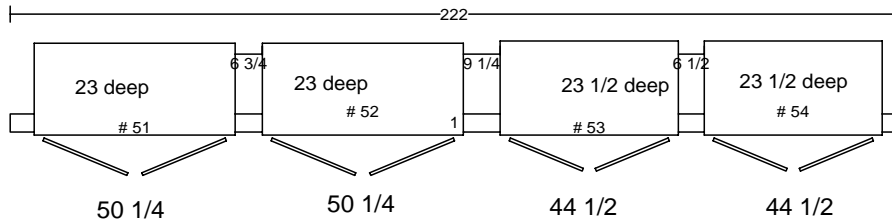
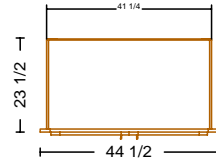
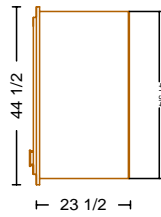
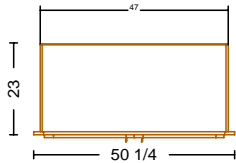
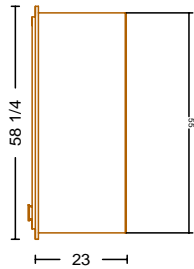

flipper doors no hardware
contractor will install doors

