

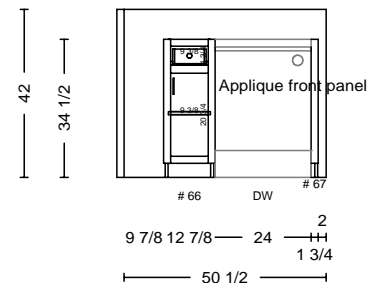

DATE	<h1>THARP CABINET ORDER</h1>			FRAMES	
JOB #					
Sheet 2 of 10					
Description COS		Address 8451 Sand Dollar Dr., Fort Collins			
Name Parade Home		WOOD	SOFFIT		
Phone 566-1635		STAIN	DOOR		
Contact Kurt		EDGE	DRAWER		
UPPERS		TOPS		FINGERPULLS	
INSTALL	DELIVER		FLOORS		HINGE

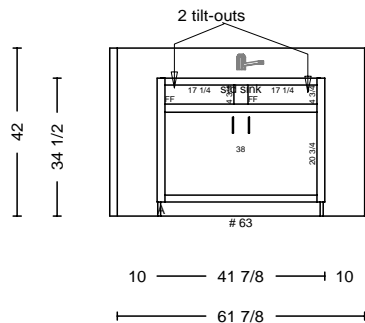

DATE	<h1>THARP CABINET ORDER</h1>			FRAMES
JOB #				
Sheet 3 of 10				
Description COS		Address 8451 Sand Dollar Dr., Fort Collins		
Name Parade Home		WOOD	SOFFIT	
Phone 566-1635		STAIN	DOOR	
Contact Kurt		EDGE	DRAWER	
UPPERS		TOPS	FINGERPULLS	
INSTALL	DELIVER	FLOORS	HINGE	

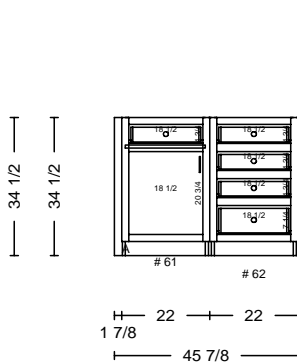
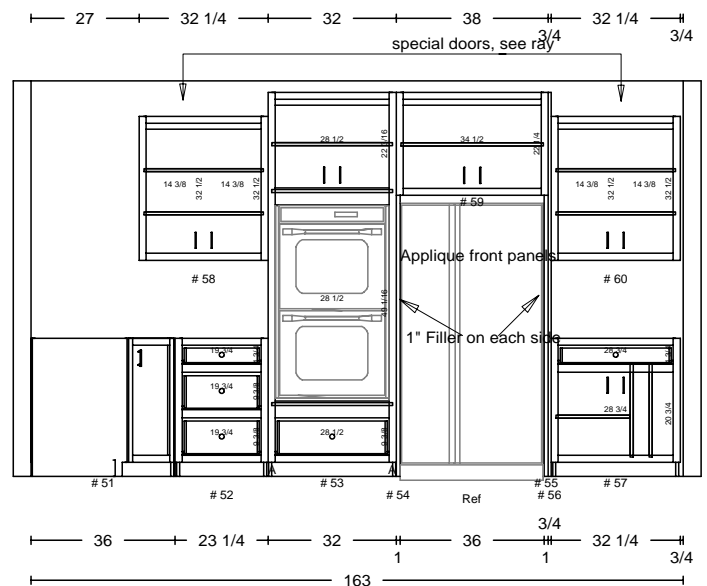
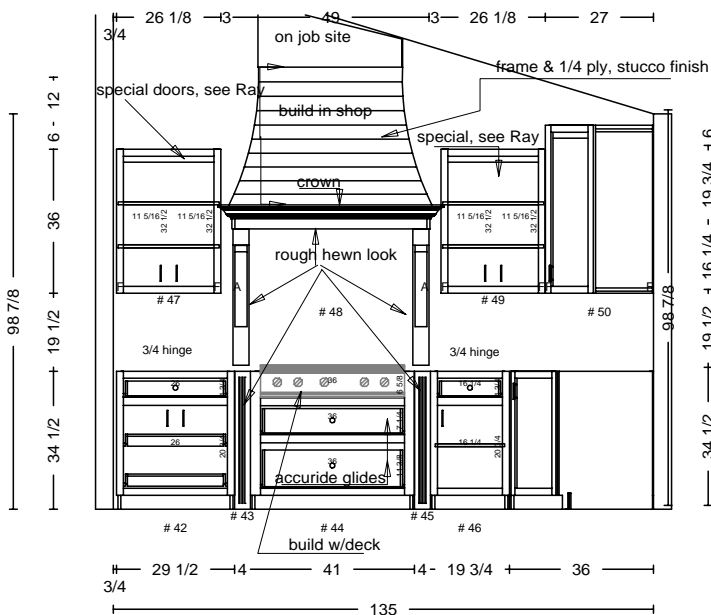
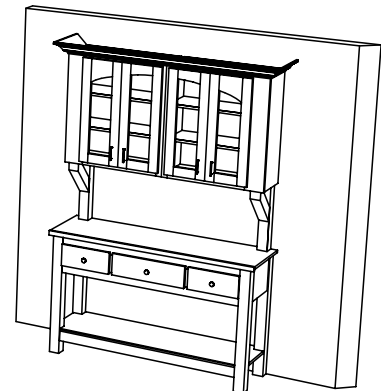
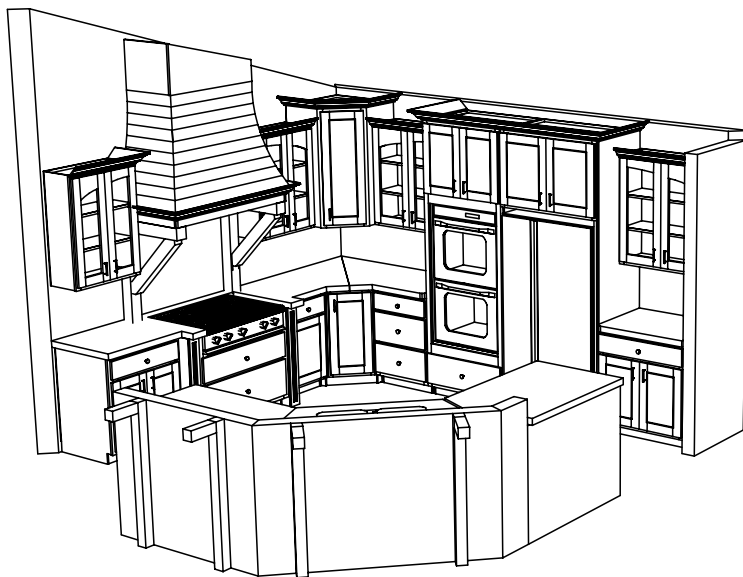
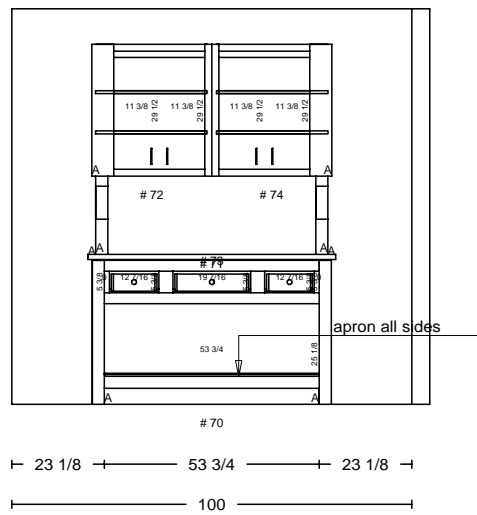
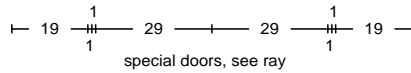

DATE	<h1>THARP CABINET ORDER</h1>			FRAMES	
JOB #					
Sheet 4 of 10					
Description COS		Address 8451 Sand Dollar Dr., Fort Collins			
Name Parade Home		WOOD	SOFFIT		
Phone 566-1635		STAIN	DOOR		
Contact Kurt		EDGE	DRAWER		
UPPERS		TOPS	FINGERPULLS		
INSTALL	DELIVER	FLOORS	HINGE		

inset cabinets 3/4"

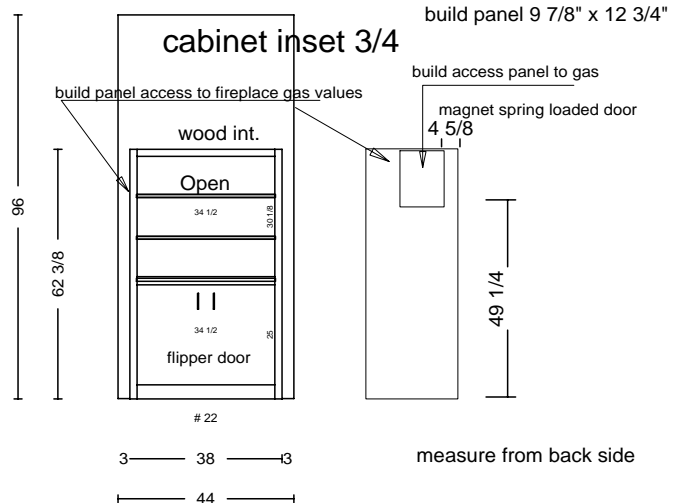
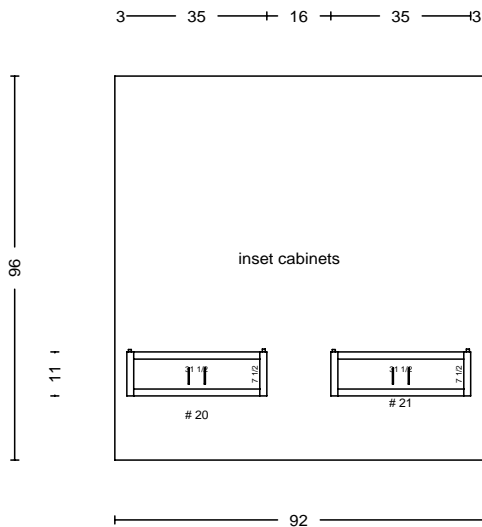
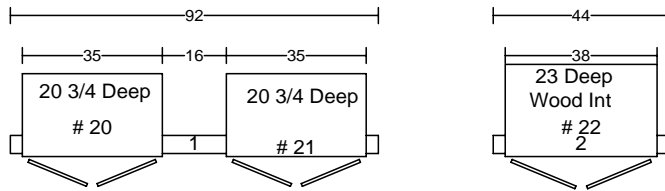

DATE	<h1>THARP CABINET ORDER</h1>			FRAMES	
JOB #					
Sheet 5 of 10					
Description COS		Address 8451 Sand Dollar Dr., Fort Collins			
Name Parade Home		WOOD	SOFFIT		
Phone 566-1635		STAIN	DOOR		
Contact Kurt		EDGE	DRAWER		
UPPERS		TOPS		FINGERPULLS	
INSTALL	DELIVER		FLOORS		HINGE

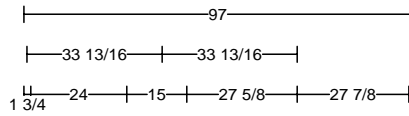

Granite Top

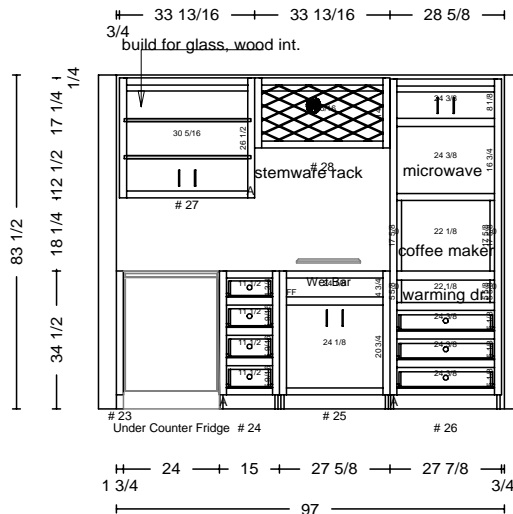
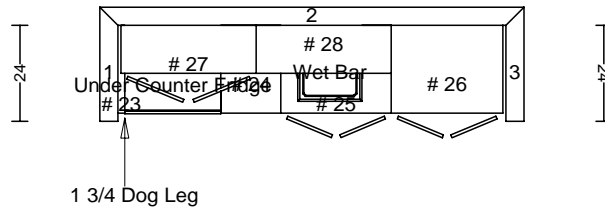

DATE	<h1>THARP CABINET ORDER</h1>		FRAMES	
JOB #				
Sheet 6 of 10				
Description COS		Address 8451 Sand Dollar Dr., Fort Collins		
Name Parade Home		WOOD	SOFFIT	
Phone 566-1635		STAIN	DOOR	
Contact Kurt		EDGE	DRAWER	
UPPERS		TOPS	FINGERPULLS	
INSTALL	DELIVER	FLOORS	HINGE	

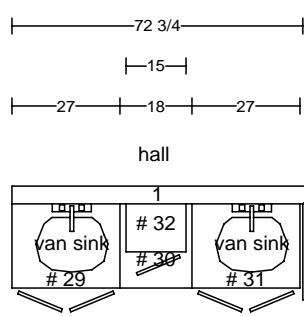

Tile Tops  
Tile Edge

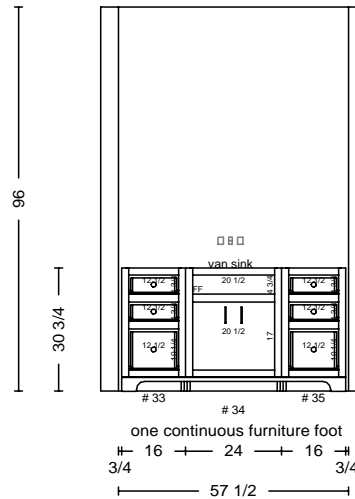
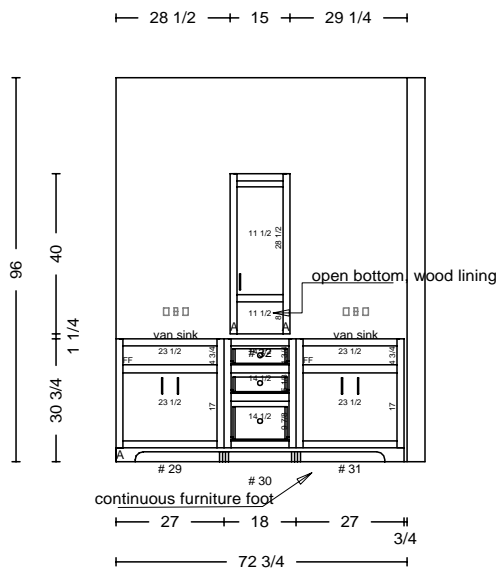
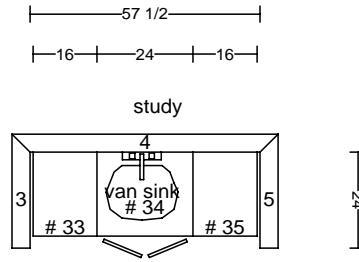

DATE	<h1>THARP CABINET ORDER</h1>		FRAMES	
JOB #				
Sheet 7 of 10				
Description COS		Address 8451 Sand Dollar Dr., Fort Collins		
Name Parade Home		WOOD	SOFFIT	
Phone 566-1635		STAIN	DOOR	
Contact Kurt		EDGE	DRAWER	
UPPERS		TOPS	FINGERPULLS	
INSTALL	DELIVER	FLOORS	HINGE	

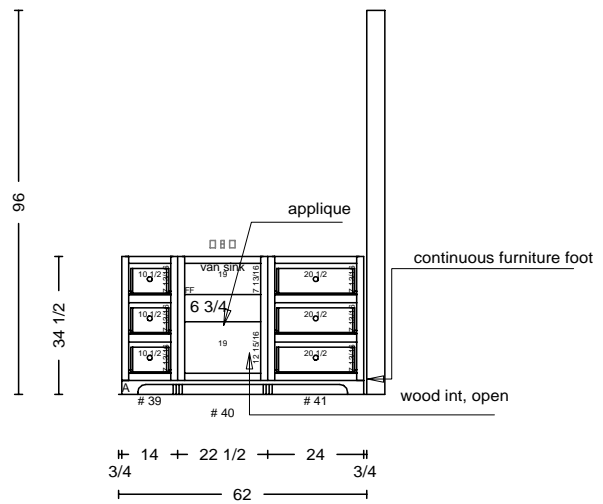
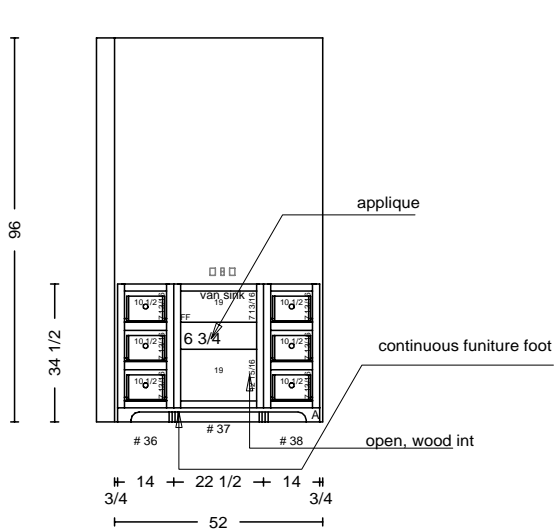
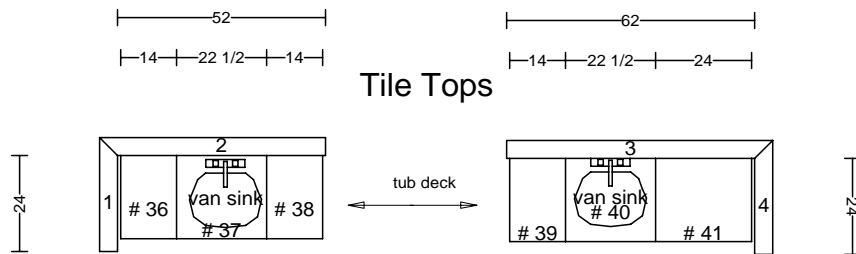

DATE	<h1>THARP CABINET ORDER</h1>		FRAMES	
JOB #				
Sheet 8 of 10				
Description COS		Address 8451 Sand Dollar Dr., Fort Collins		
Name Parade Home		WOOD	SOFFIT	
Phone 566-1635		STAIN	DOOR	
Contact Kurt		EDGE	DRAWER	
UPPERS		TOPS		FINGERPULLS
INSTALL	DELIVER	FLOORS		HINGE

Select Alder  
Nutmeg  
Formica Tops  
Wood Edge

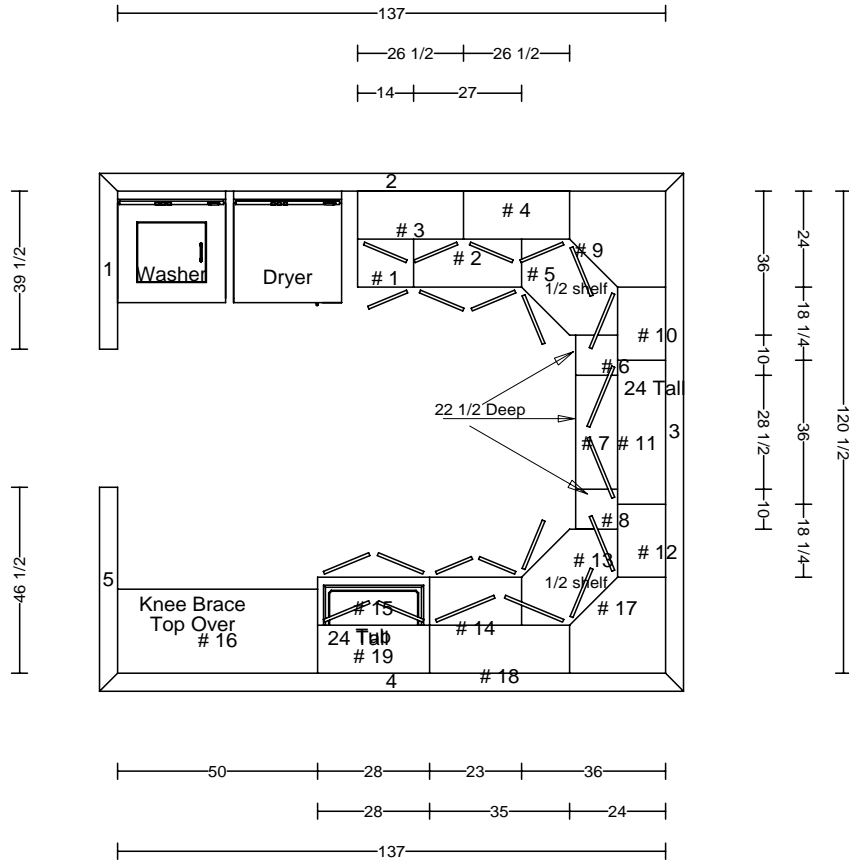



DATE	<h1>THARP CABINET ORDER</h1>			FRAMES	
JOB #					
Sheet 9 of 10					
Description COS		Address 8451 Sand Dollar Dr., Fort Collins			
Name Parade Home		WOOD		SOFFIT	
Phone 566-1635		STAIN		DOOR	
Contact Kurt		EDGE		DRAWER	
UPPERS		TOPS		FINGERPULLS	
INSTALL	DELIVER		FLOORS		HINGE

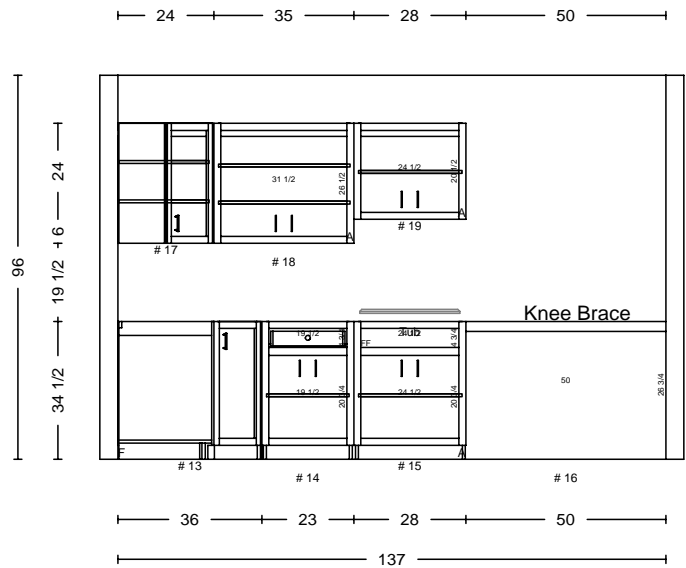
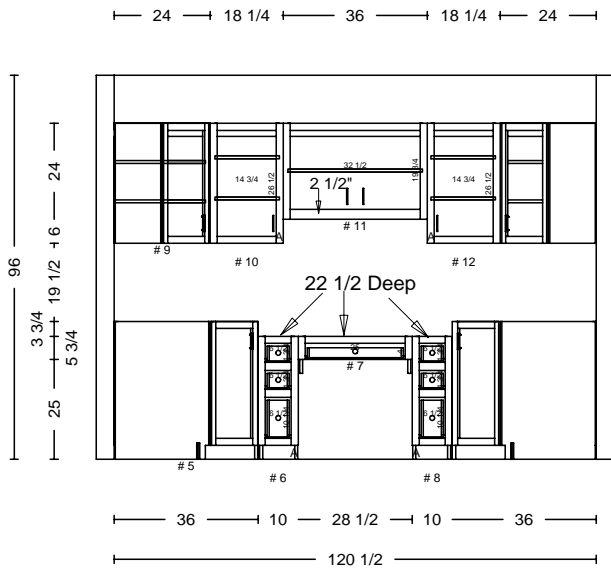
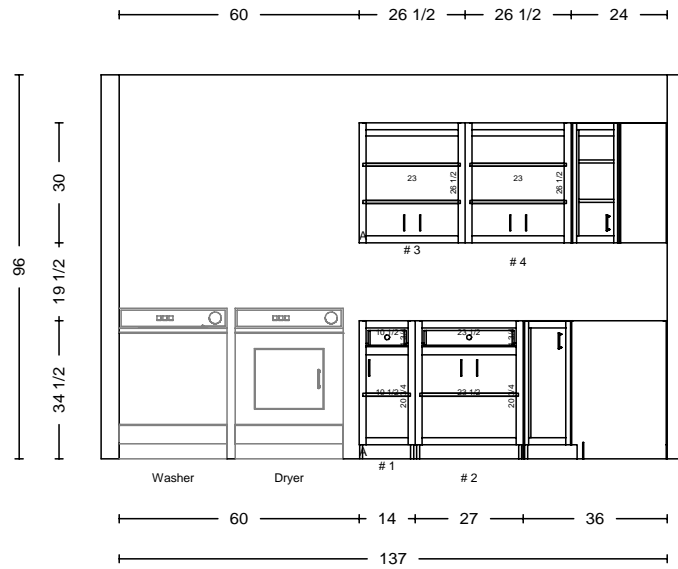

DATE	<h1>THARP CABINET ORDER</h1>			FRAMES	
JOB #					
Sheet 10 of 10					
Description COS		Address 8451 Sand Dollar Dr., Fort Collins			
Name Parade Home		WOOD	SOFFIT		
Phone 566-1635		STAIN	DOOR		
Contact Kurt		EDGE	DRAWER		
UPPERS		TOPS		FINGERPULLS	
INSTALL	DELIVER		FLOORS		HINGE

